

OPERATING MANUAL

DISKOMAT 5;6;8

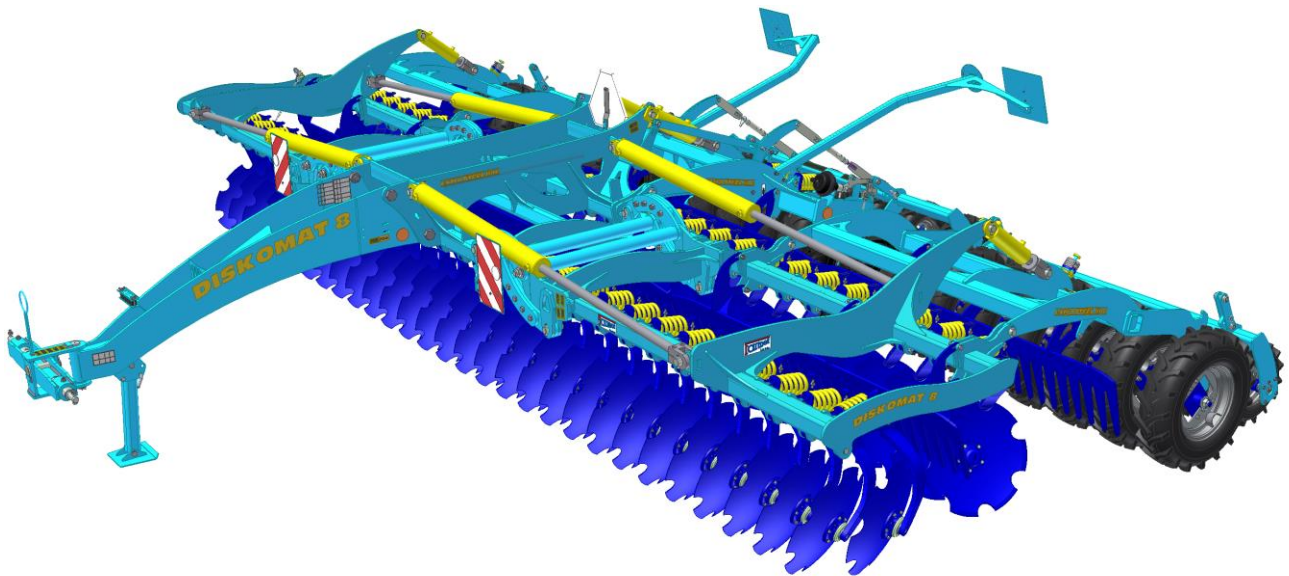

Edition: 6 | effective from: 1.9.2016

Dear customer,

Carried discs plough-harrow **DISKOMAT** are quality products of Farmet a.s. Ceska Skalice.

You can fully utilise the advantages of your machine after thoroughly studying the operating manual.





The serial number of the machine is punched on the production label and written in the operating manual (see Table 1). This machine serial number must be stated whenever ordering spare parts for possible repairs. The production label is located on the middle frame near the tow bar.

Use only spare parts for these machines according to the **Spare parts catalogue** officially issued by the manufacturer, Farmet a.s. Ceska Skalice.





Possibilities of Use of the Disc Plough-harrow

The **DISKOMAT** disc plough-harrow is intended for ploughing all types of soil up to the depth of 180 cm (7,1 in).

Production label of the machine **DISKOMAT 5**

				Farmet a.s. Jilfinková 276 Česká Skalice
TYP / VARIANTA	DISKOMAT / DISKOMAT 5			
ČÍSLO SCHVÁLENÍ	7753-10			
ROK VÝROBY / VÝROBNÍ ČÍSLO				
MAX. PŘÍPUSTNÁ HMOTNOST	6200	kg		
MAX. PŘÍPUSTNÁ HMOTNOST NA NÁPRAVĚ	4650	kg		

Production label of the machine **DISKOMAT 6**

				Farmet a.s. Jilfinková 276 Česká Skalice
TYP / VARIANTA	DISKOMAT / DISKOMAT 6			
ČÍSLO SCHVÁLENÍ	7753-08			
ROK VÝROBY / VÝROBNÍ ČÍSLO				
MAX. PŘÍPUSTNÁ HMOTNOST	6950	kg		
MAX. PŘÍPUSTNÁ HMOTNOST NA NÁPRAVĚ	5200	kg		

Production label of the machine **DISKOMAT 8**





				Farmet a.s. Jilfinková 276 Česká Skalice
TYP / VARIANTA	DISKOMAT / DISKOMAT 8			
ČÍSLO SCHVÁLENÍ	7753-09			
ROK VÝROBY / VÝROBNÍ ČÍSLO				
MAX. PŘÍPUSTNÁ HMOTNOST	8660	kg		
MAX. PŘÍPUSTNÁ HMOTNOST NA NÁPRAVĚ	6440	kg		

Table 1 - Your Machine Characteristics

MACHINE TYPE	
MACHINE SERIAL NUMBER	
SPECIAL DESIGN OR ACCESSORIES

TABLE OF CONTEINS

MACHINE LIMIT PARAMETERS.....	4
Technical parameters.....	4
Safety statement	4
A. GENERAL INSTRUCTIONS FOR USE.....	5
Protective tools.....	5
B. MACHINE TRANSPORT USING TRANSPORT MEANS	6
C. MACHINE HANDLING USING LIFTING EQUIPMENT	6
D. WORK SAFETY LABELS	6
1. DESCRIPTION.....	9
Work parts of the machine	9
2. MACHINE ASSEMBLY AT THE CUSTOMER.....	12
3. COMMISSIONING	12
3.1 Agregation to a tractor	13
3.2 Hydraulics connection	13
3.3 Folding and unfolding of the machine.....	14
Procedure for unfolding of the machine.....	15
Procedure for folding the machine	16
4. MACHINE TRANSPORT ON ROADS	17
5. MACHINE ADJUSTMENT	18
5.1 Machine working depth adjustment on rollers	19
5.2 Setting the longitudinal plane of the machine	19
5.3 Exclusion of rear rubber-tyred rollers	21
6. MACHINE MAINTENANCE AND REPAIRS.....	22
7. MACHINE STORAGE.....	23
8. MACHINE LUBRICATION SCHEDULE	23
9. ENVIRONMENTAL PROTECTION	24
10. MACHINE DISPOSAL AFTER SERVICE LIFE EXPIRY	24
11. SERVICING AND WARRANTY CONDITIONS	24
LETTER OF GUARANTE.....	25
CE Certificate of Conformity.....	26

MACHINE LIMIT PARAMETERS

- ^(x) The machine is designed for soil ploughing up to a depth of 18 cm (7,1 in) when agricultural soil cultivation. Another type of use exceeding the determined purpose is forbidden.
- ^(x) The machine is only operated by one person – the tractor driver
- ^(x) Machine operator must not use the machine in a different way, especially:
 - ^(x) Transport of persons and animals on the machine structure,
 - ^(x) Transport of burdens on the machine structure,
- ^(x) Aggregation of the machine with another towing equipment than stated in Chapter "3.1."

TECHNICAL PARAMETERS

Tab. 2 – Technical Parameters

PARAMETRY		DISKOMAT 5	DISKOMAT 6	DISKOMAT 8
Working width		5m / 16,4ft	6m / 19,7ft	7,8m / 25,6ft
Transport width		3m (9,84ft)		
Transport height		3,3m (10,83ft)	3,3m (10,83ft)	4m (13,1ft)
Machine total length		6,6m (21,65ft)		
Working depth		6–18cm (2,4-7,1in)		
Number of discs Ø620	front	20	24	30
	rear	20	24	30
Working performance		5–7,5ha/h (12,4-18,5ac/h)	6–9ha/h (14,8-22,2ac/h)	8–12ha/h (19,8-29,7ac/h)
Towing means		150–220kW* (200-300HP)*	180–260kW* (240-350HP)*	240–300kW* (320-400HP)*
Working speed		10–15km/h (6-9mph)		
Maximum transport speed		25km/h (15mpa)		
Maximum slope grade		6°		
Tyre dimensions - transport	Tyre pressure (kPa)	10.0/75-15,3 10PR		400 kPa (58 Psi)
Tyre dimensions - rollers	Tyre pressure (kPa)	7.50-16 8PR		325 kPa (47 Psi)
Tyre dimensions - additional	Tyre pressure (kPa)	5,0-10 4PR		200 kPa (29 Psi)
Tyre dimensions - transport	Tyre pressure (kPa)	19,0/45-17 14PR		400 kPa (58 Psi)
Machine weight		6 200kg (13 700 lb)	6 950kg (15 320 lb)	8 660kg (19 100 lb)





* Recommended towing means, the real towing force may significantly vary according to the processing depth, soil conditions, land slope, working body wear and adjustment

** The tyres are used on the separate transport axle when the machine is equipped with other than double pneumatic roller

SAFETY STATEMENT

	This warning sign warns about an immediate dangerous situation ending with death or severe injury.
	This warning sign warns about a dangerous situation ending with death or severe injury.
	This warning sign warns about a situation that may end with a smaller or slight injury. It also warns about dangerous actions related to the activity that could lead to an injury.

A. GENERAL INSTRUCTIONS FOR USE

- A.1** ^(x) The machine is made in accordance with the latest equipment state and approved safety regulations. However, dangers of user or third person injury or machine damage or creation of other material damage may arise during use.
- A.2** ^(xx) Use the machine only in a technically sound condition, in accordance with its purpose, aware of possible dangers, and while adhering to the safety instructions of this operating manual!
The Manufacturer is not liable for damages caused by the use of the machine that is in contradiction with the limit parameters of the machine (p. 4) and with the instructions for the use of the machine (Chapter A and 3). The User bears the risk.
Immediately remove especially the failures that may negatively affect safety!
- A.3** ⁽⁷⁾ Machine operation may be performed by a person authorised by the operator under these conditions:
- ⁽⁸⁾ It must own a valid driver's licence of the corresponding category,
 - ⁽⁹⁾ It must be demonstrably familiarised with the safety regulations for work with the machine and must practically master the machine operation,
 - ⁽¹⁰⁾ The machine may not be operated by juveniles,
 - ⁽¹¹⁾ It must know the meaning of the safety signs located on the machine. Their respecting is important for safe and reliable machine operation.
- A.4** ⁽¹²⁾ Maintenance and servicing repairs on the machine may only be performed by a person:
- ⁽¹³⁾ Authorised by the operator,
 - ⁽¹⁴⁾ Educated in the machinery field with knowledge of repairs of similar machines,
 - ⁽¹⁵⁾ Demonstrably familiarised with safety regulations for work with the machine,
 - ⁽¹⁶⁾ During a repair of a machine connected to a tractor, it must own a driver's licence of the corresponding category.
- A.5** ⁽¹⁷⁾ Machine operator must secure the safety of other persons when working with the machine or transporting the machine.
- A.6** ⁽¹⁸⁾ During machine work in the field or during transport, the operator must control the machine from the tractor's cabin. *požadována přítomnost obsluhy na konstrukci stroje ⇒ obsluha musí stroj ovládat z kabiny traktoru.*
-  **A.7** ⁽¹⁹⁾ The operator may enter the machine structure only with the machine at rest and blocked against movement, namely only for these reasons:
- ⁽²⁰⁾ Adjustment of the machine working parts,
 - ⁽²¹⁾ Repair and maintenance of the machine,
 - ⁽²⁹⁾ Release and securing of spherical valves of the axle,
 - ⁽²⁷⁾ Securing of spherical valves of the axle before folding the side frames,
 - ⁽²⁸⁾ Adjustment of the working parts of the machine after unfolding the side frames.
-  **A.8** ^(xxx) When stepping on the machine, do not step on tyres, rollers, discs or other rotary parts. Those may turn and you can cause very serious injuries by the subsequent fall.
-  **A.9** ⁽²²⁾ Any changes or modifications of machine may be performed only with written consent of the manufacturer. For possible damage arisen due to ignoring this instruction, the producer bears no responsibility. The machine must be maintained equipped with prescribed accessories and equipment including safety marking. All warning and safety signs must be legible and in their places. In case of damage or loss, these signs must be immediately renewed.
- A.10** ⁽²³⁾ The operator must have the Operating Manual with the work safety requirements available at any time when working with the machine.
-  **A.11** ⁽²⁴⁾ The operator must not consume alcohol, medicines, narcotic and hallucinogenic substances that decrease his attention and coordination capabilities while using the machine. If the operator must use medicines prescribed by a physician or uses freely sold medicines, he must be informed by a physician, whether he is capable of responsible and safe operation of the machine under these circumstances.

PROTECTIVE TOOLS

For the operation and maintenance use:

- Tight clothes
- Protective gloves and goggles for protection against dust and sharp parts of the machine



B. MACHINE TRANSPORT USING TRANSPORT MEANS

- B.1** ⁽¹⁾ The transport means designed for machine transport must have the load capacity minimally identical with the weight of the transported machine. The total weight of the machine is stated on the production label.
- B.2** ⁽²⁾ The dimensions of the transported machine including the transport means must comply with the valid regulations for road traffic (decrees, laws).
- B.3** ⁽³⁾ The transported machine must be always fastened to the transport means so that its spontaneous loosening could not happen.
- B.4** ⁽⁴⁾ The carrier is responsible for damage caused by the loosening of incorrectly or insufficiently fastened machine to the transport means.

C. MACHINE HANDLING USING LIFTING EQUIPMENT

- C.1** ⁽¹⁾ The lifting equipment and tying means designed for handling of the machine must have their load capacity at least identical with the weight of the handled machine.
- C.2** ⁽²⁾ Machine fastening for handling may only be performed in places designed for that and marked with self-adhesive labels showing the "chain" symbol. 
- C.3** ⁽³⁾ After fastening (suspending) at designated points, it is forbidden to move in the space of possible reach of the handled machine.

D. WORK SAFETY LABELS

Warning safety labels serve for operator protection.

General:



A) Strictly observe the warning safety labels.

B) All safety instructions also apply to other users.

C) Upon damage or destruction of the aforementioned "SAFETY LABEL" located on the machine, THE OPERATOR IS OBLIGED TO REPLACE IT WITH A NEW ONE!!!

The position, appearance, and precise meaning of work safety labels on the machine is determined in the following tables (Tab. 3/page 6-7) and in the figure (Fig. 1/page 8).

Table 3 – Self-adhesive warning safety labels located on the disc plough-harrow

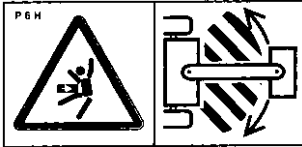
WARNING SAFETY LABEL	LABEL TEXT	MACHINE POSITION
	<p>Before handling the machine, carefully read the operating manual. Observe the instructions and safety regulations for machine operation during use.</p>	P 1 H
	<p>When connecting or disconnecting, do not step between the tractor and the machine, also do not enter this space, if the tractor and the machine are not at rest and the engine is not turned off.</p>	P 2 H
	<p>Stay outside the reach of the tractor - agricultural machine set, if the tractor engine is in operation.</p>	P 6 H

	<p>Before commencing the machine transport, secure the axle with spherical valves against unexpected drop.</p>	<p>P 13 H</p>
	<p>When folding the side frames, do not reach into the space of the machine folding joints. There is a danger of cutting when setting the depth of the machine.</p>	<p>P 20 H</p>
	<p>Travelling and transport on the machine structure is strictly forbidden.</p>	<p>P 37 H</p>
	<p>When working and transporting the machine, maintain safe distance from the electric appliances.</p>	<p>P 39 H</p>
	<p>When folding and unfolding the side frames, stay outside their reach.</p>	<p>P 50 H</p>
	<p>Secure the machine against unwanted movement by positioning on its working bodies (discs).</p>	<p>P 52 H</p>
	<p>Do not approach the rotary parts of the machine, if these are not at rest, i.e. they do not turn.</p>	<p>P 53 H</p>
	<p>It is strictly folding and unfolding the side frames on slopes or inclined surfaces.</p>	<p>P 100 H</p>
	<p>The shown positions of the lever and the function of the hydraulic spherical valve located on the piston rod.</p>	<p>P 101 H</p>

Fig. 1 - Location of safety labels on the **DISKOMAT** machine

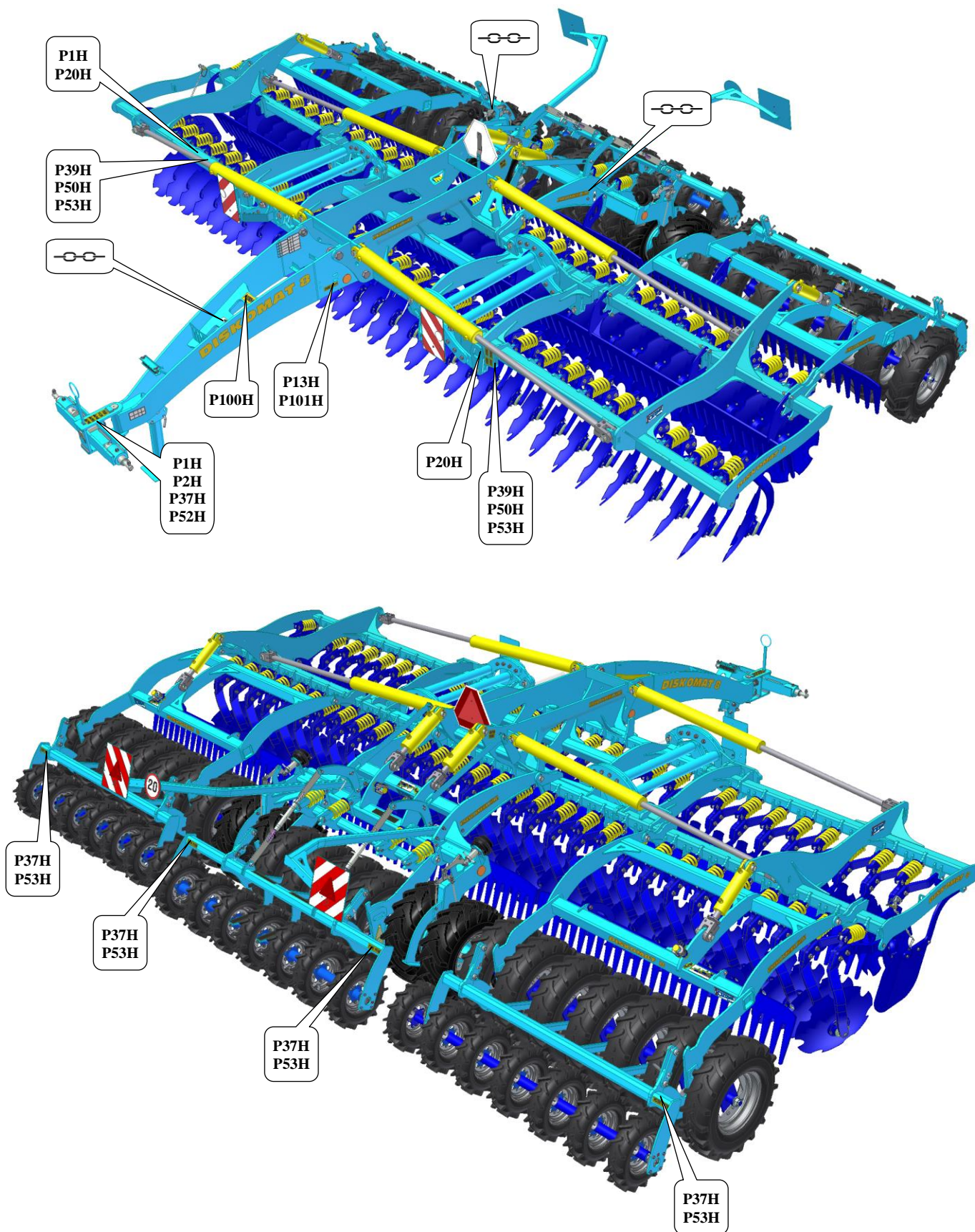

1. DESCRIPTION

The **DISKOMAT 5, DISKOMAT 6, DISKOMAT 8** machines are constructed as semi-carried. The basic version consists of a tractive pole with a TPS suspension bar with Ø36mm or Ø60mm pivots for the TPS 3 and KIROVEC category, (when requested, the machine can be equipped with a hydraulic pole for the fixed tractor hitch with Ø50mm or Ø70mm or with K80 hitch). There are a central frame with the transportation axle and two side frames. There are Ø620mm working discs in two rows on the central and side frames and deflectors behind the front and rear disc row which regulate and crumble the flying soil. There are rubber-tyred rollers in the rear that compact the loosened soil.

WORK PARTS OF THE MACHINE

Fig. 2a – Work Parts of the Machine

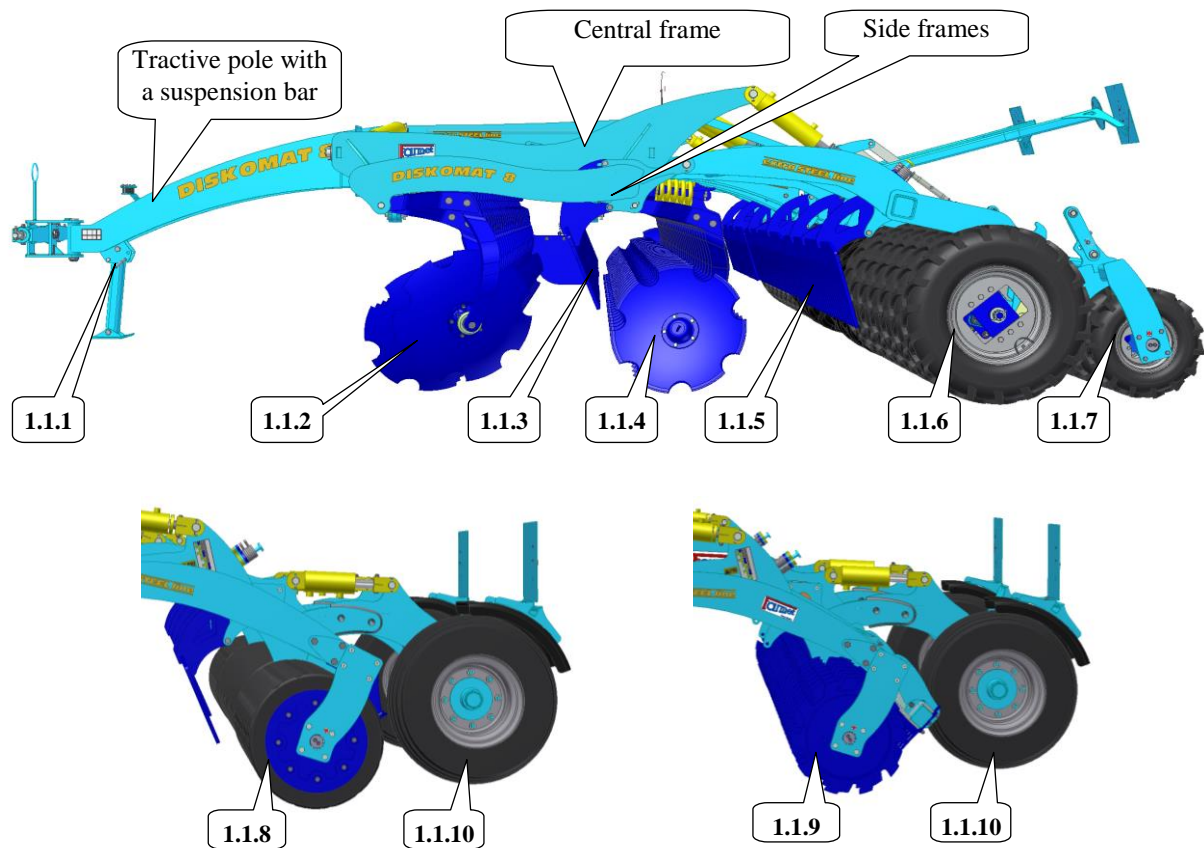

- | | | | |
|-------|---|--------|--|
| 1.1.1 | Tractive pole with a folding leg | 1.1.7 | Additional rubber-tyred roller |
| 1.1.2 | Front disc row | 1.1.8 | LTX roller |
| 1.1.3 | Front deflectors | 1.1.9 | Segmented rollers |
| 1.1.4 | Rear disc row | 1.1.10 | Transport axle– for LTX, segmented rollers |
| 1.1.5 | Rear deflectors | | |
| 1.1.6 | Rubber-tyred roller including transport. axle | | |

Fig. 2b – Hydraulic pole for the fixed tractor hitch
When requested, the machine can be equipped with a hydraulic pole for the fixed tractor hitch allowing machine depth setting.

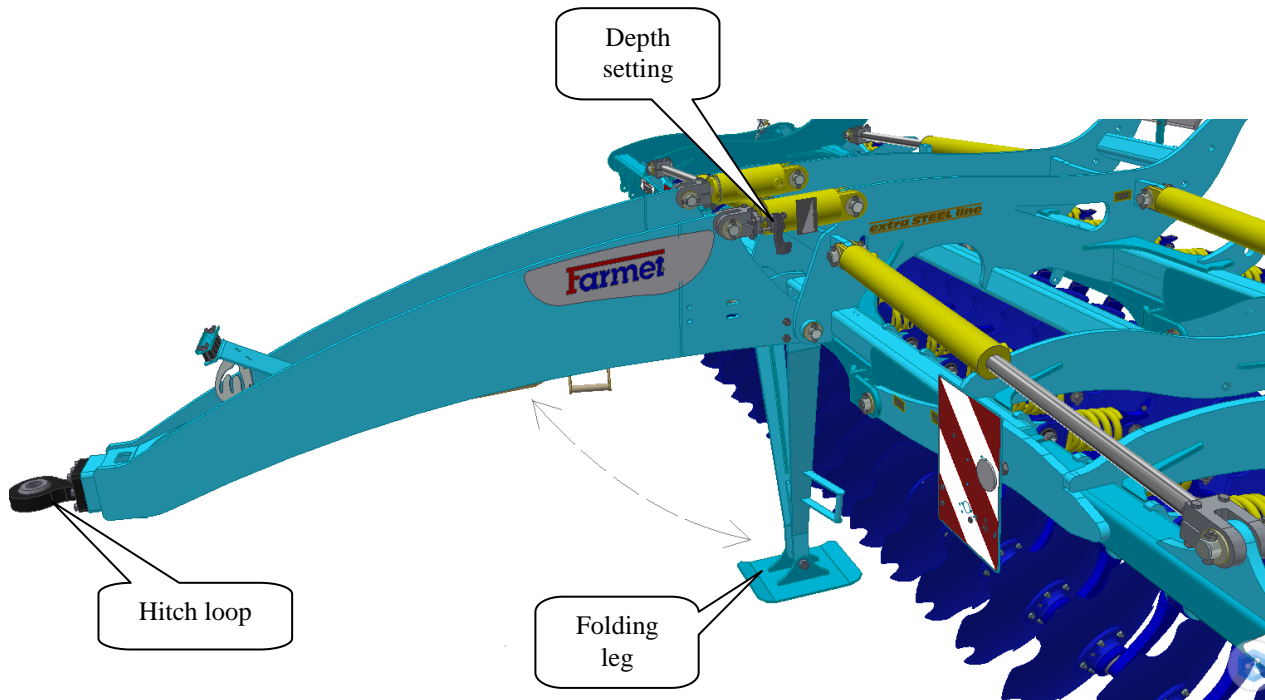
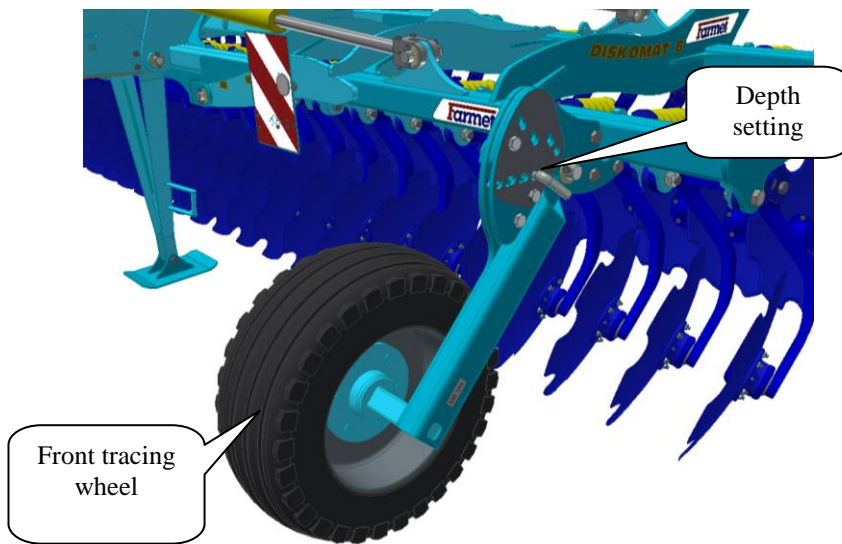
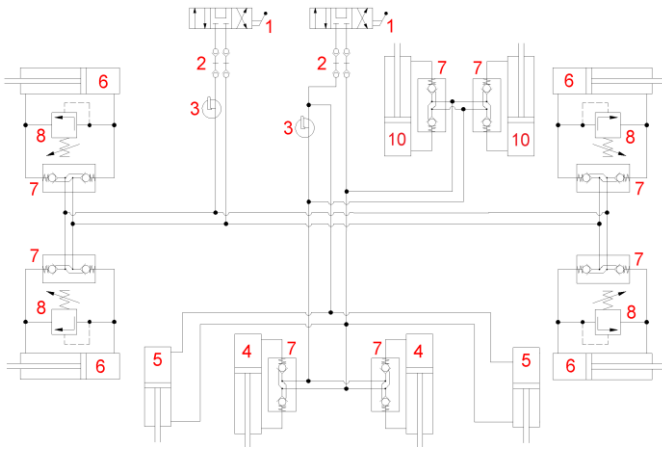

Fig. 2c – Front tracing wheel
When requested, the machine can be equipped with front tracing wheels allowing machine depth setting.



HYDRAULIC

Hydraulic diagram of DISKOMAT 5-8
Drawbar into fixed hitch / pneumatic roller



Hydraulic diagram of DISKOMAT 5-8
Drawbar into arms / pneumatic roller

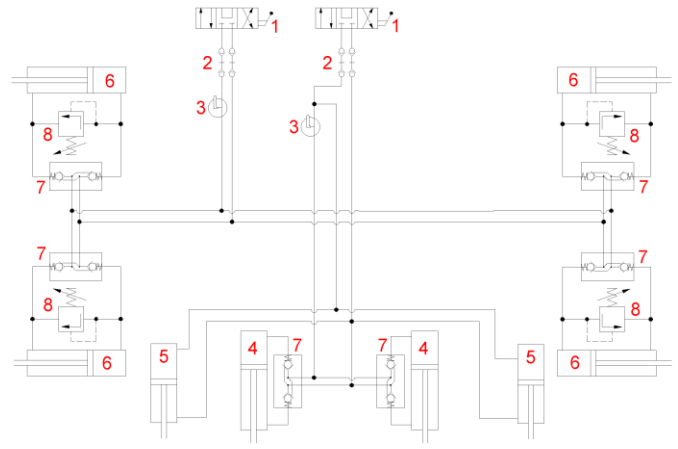

Hydraulic diagram of DISKOMAT 5-8
Drawbar into fixed hitch / other types of rollers

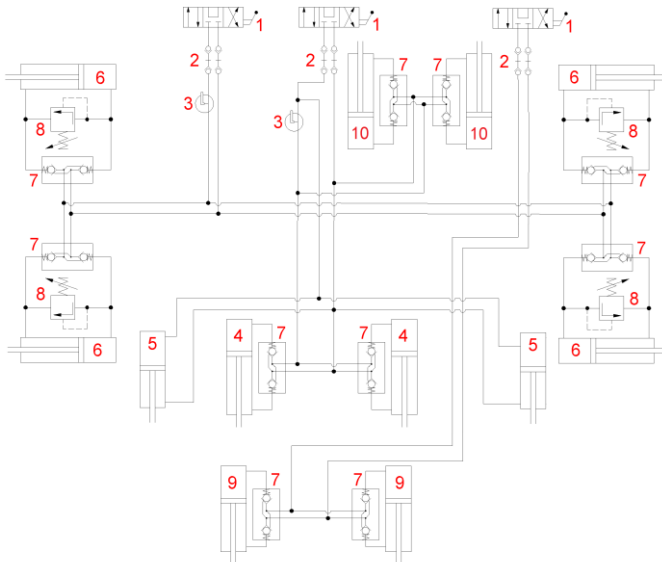

Hydraulic diagram of DISKOMAT 5-8
Drawbar into fixed hitch / other types of rollers

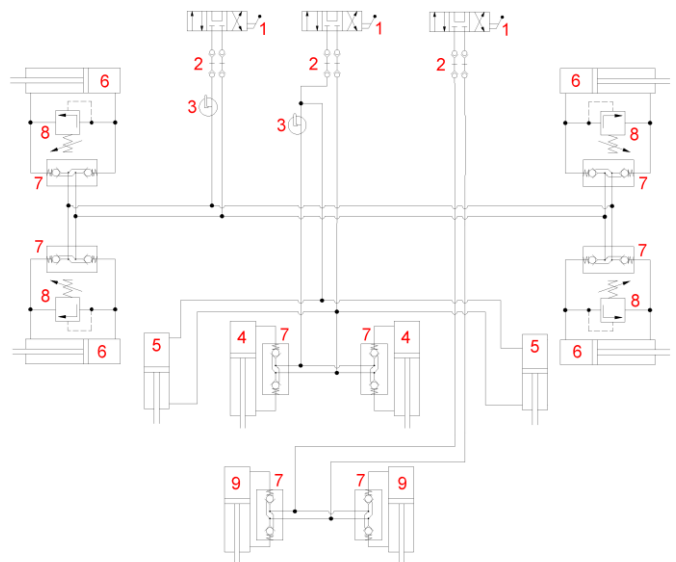

1. Control distributor (tractor)
2. Hydraulic coupling
3. Closing cock
4. Hydraulic cylinder (Central roller)
5. Hydraulic cylinder (side Rubber-tyred roller)

6. Hydraulic cylinder (folding side frames)
7. Hydraulic closing valve
8. Safety valve
9. Hydraulic cylinder (axle)
10. Hydraulic cylinder (drawbar)



Parts of the hydraulic system of the machine, which are under pressure, are forbidden to disassemble. Hydraulic oil that penetrates the skin under high pressure causes severe injuries. In case of injury, seek a physician immediately.

2. MACHINE ASSEMBLY AT THE CUSTOMER



- The operator must perform the assembly according to the instructions of the producer, best in cooperation with the expert servicing technician determined by the producer.
- The operator must secure a functional test of all assembled parts after the completion of the machine assembly.
- The operator must secure that the handling of the machine using lifting equipment during its assembly is in accordance with chapter "C".

3. COMMISSIONING



- Before taking over the machine, test and check, whether damage occurred during transport and whether all parts contained in the bill of delivery were supplied.
- Before commissioning the machine, carefully read this operating manual, especially Chapters **A-D** p. 5-8. Before the first use of the machine, familiarise yourselves with its controls and overall function.
- During work with the machine, observe not only the instructions of this operating manual but also generally valid regulations of work safety, health protection, fire and transport safety, and environmental protection.
- The operator must check the machine before every use (commissioning) from the standpoint of completeness, work safety, work hygiene, fire safety, transport safety, and environmental protection. Stroj A machine showing signs of damage must not be commissioned.
- Aggregation of the machine with the tractor is to be performed on a flat and hardened surface.
- When working on slopes, observe the lowest allowable slope grade of the set **TRACTOR - MACHINE**.
- Before starting the tractor motor, check whether no person or animal is in the working space of the set and push the warning sound signal.
- The operator is responsible for the safety and all damage caused by the operation of the tractor and the connected machine.
- The operator is obliged to adhere to the technical and safety regulations of the machine determined by the producer when working.
- When turning the machine at headland, the Operator must lift the machine, i.e. the working bodies are not in the ground.
- The operator is obliged to observe the prescribed working depths and speeds stated in the manual in Tabl. 2/p. 4 when
- The operator is obliged to lower the machine to the ground and secure the set against movement before leaving the tractor cabin.



DECREASE OF SOIL PRESSURE TO A VALUE LOWER THAN 200kPa (29 Psi)

- To decrease the specific pressure on soil (below 200kPa) at the turns on the headland, raise the machine on the pole by using the hydraulic tractor shoulders and rear wheels. Turn around when the machine is unfolded and resting on all rear wheels.

3.1 AGREGATION TO A TRACTOR

- The machine may only be connected to a tractor with a service weight and parameters allowing for safe work with the attached machine and its safe transportation on roads.
- The machine operator must observe all generally valid regulations of work safety, health protection, fire safety, and environmental protection.
- The operator may connect the machine exclusively to a tractor that is equipped with a rear three-point suspension (or bottom fixed hitch) and a functional undamaged hydraulic system.
- The table of requirements for the towing means for work with the machine:

⁽⁵⁾ Requirement for the tractor engine power for disc plough-harrow DISKOMAT 5		150-220 kW (200-300HP)	
⁽⁵⁾ Requirement for the tractor engine power for disc plough-harrow DISKOMAT 6		180-260 kW (240-350HP)	
⁽⁵⁾ Requirement for the tractor engine power for disc plough-harrow DISKOMAT 8		240-300 kW (320-400HP)	
⁽⁶⁾ Requirement for the tractor's TPS	Three-point hitch arms	⁽⁷⁾ Spacing of the lower suspension joints (measured at the joint axes)	1010±1,5 mm (39,76 in)
		⁽⁸⁾ ∅ of the hole of the lower suspension joints for the machine suspension pivots	∅37,5 mm (∅1,48 in)
	Fixed hitch	Height of the bottom fixed hitch	500 – 600 mm (19,7 - 23,6 in)
		Mechanism of aggregation of the bottom fixed hitch	Pin ∅ 50mm (1,96 in)
			Pin ∅ 70mm (2,75 in)
		Ball K80	
⁽⁹⁾ Requirement for the tractor's hydraulic system	⁽¹⁰⁾ Side frame folding circuit		⁽¹⁴⁾ Circuit pressure 200 bar (2900 Psi), 2 pcs of quick-coupler sockets ISO 12,5
	Circuit for lifting the machine on the rollers		⁽¹⁵⁾ Circuit pressure 200 bar (2900 Psi), 2 pcs of quick-coupler sockets ISO 12,5
	Axle lifting circuit*		⁽¹⁵⁾ Circuit pressure 200 bar (2900 Psi), 2 pcs of quick-coupler sockets ISO 12,5
⁽¹²⁾ Requirement for the pneumatic tractor system	⁽¹³⁾ Machine axle braking circuit		⁽¹⁶⁾ Circuit pressure min. 6 bar – max. 8,5 bar (87-123 Psi), 1 pc coupling head of single-hose brakes

* not valid for machines with double pneumatic-tyred rollers

- Connect the machine using the TPS suspension bar to the lower arms of the rear TPS of the tractor, secure the TPS arms using pins against disconnecting, or connect the machine to the bottom fixed hitch and secure it against disconnecting.
- If the drawbar is equipped with a safety chain, connect it to the tractor.



When connecting, no persons may stay in the space between the tractor and the machine.

3.2 HYDRAULICS CONNECTION

- Connect the hydraulics only when the hydraulic circuits of the machine and the tractor (aggregate) are in a pressure-less condition.
- The hydraulic system is under high pressure. Regularly check for leaks and immediately remove obvious damage of all lines, hoses, and pipe unions.
- When seeking and removing leaks, use only the suitable tools.
- For connecting the hydraulic system of the machine to the tractor, use the plug (on the machine) and the socket (on the tractor) of the quick-couplers of the same type. Perform the connection of the quick-couplers of the machine to the hydraulic circuits of the tractor so that the folding of the side frames (**RED CIRCUIT**) is on one control circuit, axle lifting (or lifting the axle and the drawbar) (**YELLOW CIRCUIT**) on the other control circuit, or the separate circuit of the axle (**GREEN CIRCUIT**) on the third control circuit.

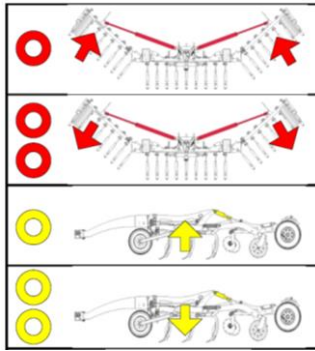

Red Circuit

- 1 tape – for folding side frames into the transport position
- 2 tapes – for unfolding side frames into the working position

Yellow Circuit

- 1 tape – lifting the machine
- 2 tapes – recessing the machine

Separate axle circuit (for LTX, RING and segmented rollers):

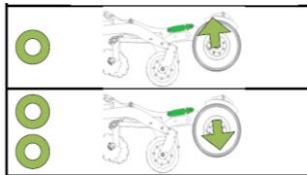

Green Circuit

- 1 tape – lowering the machine from the axle
- 2 tapes – lifting the machine on the axle



In order to prevent accidental or foreign person (children, passengers) caused movement of the hydraulics, the control switchboards on the tractor must be secured or blocked in the transport position.

3.3 FOLDING AND UNFOLDING OF THE MACHINE



- The hydraulics for the folding and unfolding must be connected to the double-action control unit.
- The operator must ensure that during folding and unfolding of the side frames, no person or animal is within their reach (i.e. at the place of their impact) or vicinity
- Perform folding and unfolding on flat and solid surfaces or laterally to the slope with the fully open control unit.
- Only perform folding or unfolding with a machine that is lifted on the axle and the side rubber-tyres of the rollers are recessed, i.e. their piston-rods are retracted.
- Remove stuck soil from folding points, soil may impair function and cause damage to the mechanics.
- During folding or unfolding, check the side frames and have them continuously fold into the end position to the stoppers.



CAUTION!!! The machine must be lifted on the axle and the side rubber-tyres of the rollers must be recessed, i.e. their piston-rods must be retracted, when the machine is folded and unfolded. Otherwise, the wheels on the side rollers may get damaged.

machine prepared for folding

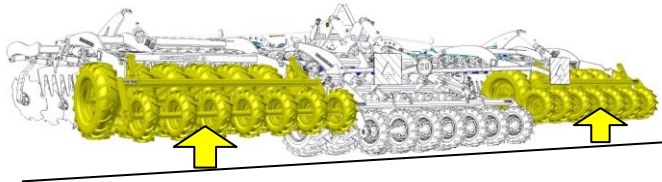

machine prepared for unfolding

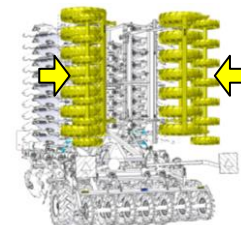

CAUTION!!! If the machine has a separate axle, it always has to be lifted on the axle prior to the start of folding and when folded!

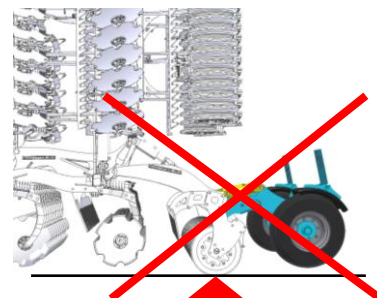
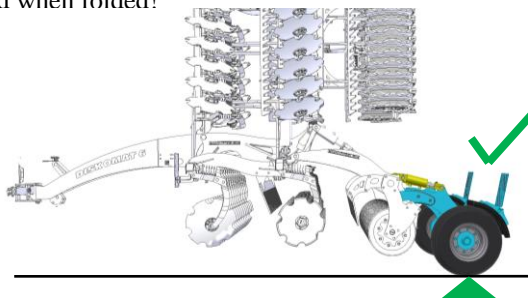

PROCEDURE FOR UNFOLDING OF THE MACHINE			
Description of the task	Position of ball valves	Pressure in the hose	Schema
1. The folded machine must be lifted on the axle (or on the axle and the drawbar) and the axle ball valve of the central roller (bottom valve) must be closed.			
2. Remove the side frame securing rod and secure it on the machine pole for work.			
3. The side rollers must be "recessed", i.e. their piston-rods must be retracted.		yellow 	
4. Unfold the machine		red 	
5a. Lower the side rollers to the ground so that the machine evenly stands on all rollers.		yellow 	
5b. When the machine is equipped with a separate axle, insert the piston-rods of the axle until the machine rests on the rollers.		green 	

PROCEDURE FOR FOLDING THE MACHINE

Description of the task	Position of ball valves	Pressure in the hose	Schema
1a. Lift the unfolded machine on all rollers, or on rollers and the drawbar.		yellow 	
1b. When the machine is equipped with a separate axle, lift the machine also on the axle.		green 	
2. Close the ball valve of the axle – the central roller (bottom valve) and use the yellow circuit to lift the side rollers so that the machine is standing.		yellow 	
3. Fold the machine.		red 	
4. Check that the side rollers are correctly folded.		yellow 	
5. Secure the side frames by the securing rod in the front, close ball valves.			

4. MACHINE TRANSPORT ON ROADS



Transport Position of *DISKOMAT 5*, *DISKOMAT 6*, *DISKOMAT 8*

- Connect the machine to the tractor using the two-point suspension device (TPS 3), or to the fixed bottom hitch using a pin or a ball.
- Connect the machine brakes to the tractor with the use of the brake head: release the brakes before raising the machine on the axle.
- Lift the machine on the axle, set the spherical valve of the axle into the closed position.
- Fold the side frames into the transportation position.
- The machine must be equipped with removable shields with marking of contours, functional lighting, and the board of the rear marking for slow vehicles (according to ECE No. 69).
- The lighting must be activated during travelling on roads.
- The tractor must be equipped with a special light device of an orange colour, which must be activated during travelling on roads.
- The maximum transport speed during travelling on roads is **20 kph**.



Ban of transport with decreased visibility!

- Bring the machine into the transport position.
- The operator is obliged to pay increased attention during transport on roads, due to the transport dimensions of the machine.
- The operator must observe the valid regulations for transport on roads (laws, decrees) after connecting the machine to the tractor, for reason of a change of the axle load. The driving properties of the set also change depending on the terrain nature, adapt the manner of driving to these conditions.
- The operator is obliged to secure sufficient outlook during reversing from his position of the tractor driver. In case of insufficient outlook, the operator is obliged to call a competent and informed person.
- The operator must fold the side frames for transport and secure them against unwanted unfolding by disconnecting the hydraulic circuit of the machine and the tractor.
- The operator must secure the arms of the rear TPS of the tractor in the transport position during road transport, i.e. prevent unexpected arm drop using the hydraulic arm control lever. At the same time, the arms of the rear TPS of the tractor must be secured against side swinging.
- During machine transport on roads, the operator must observe the valid laws and decrees that deal with this topic and which specify the relationships of the tractor axle load depending on transport speed.

5. MACHINE ADJUSTMENT

The operating depth is adjusted in the following way:

- 1) By setting the depth on the piston rods of the rear rollers
- 2) By setting the depth of the front part of the machine
 - a) On the pole
 - b) On the tracing wheels

Fig. 3a – Machine adjustment with pole in the tractor shoulders (TPS3-4)

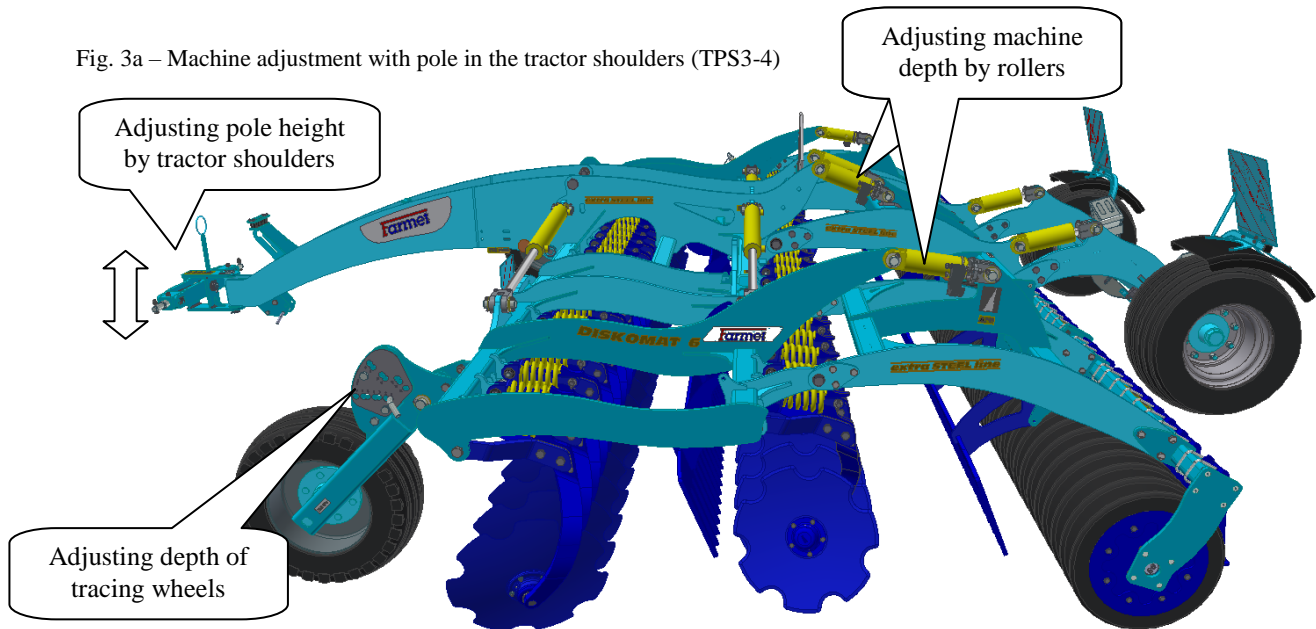
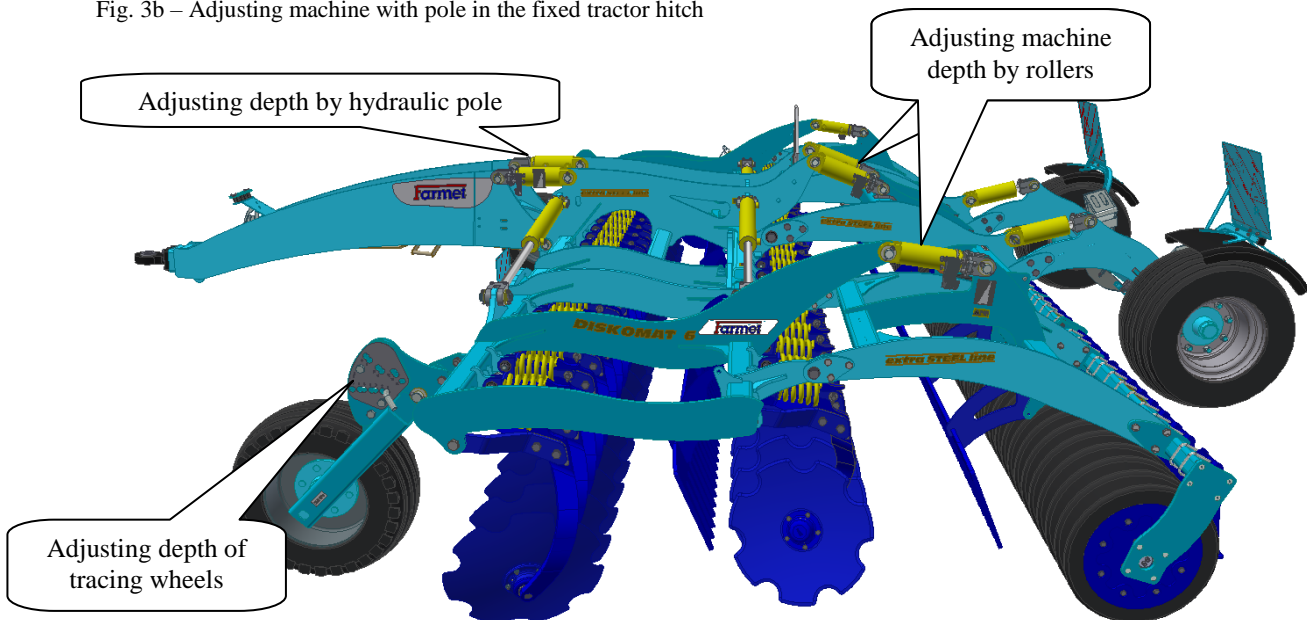
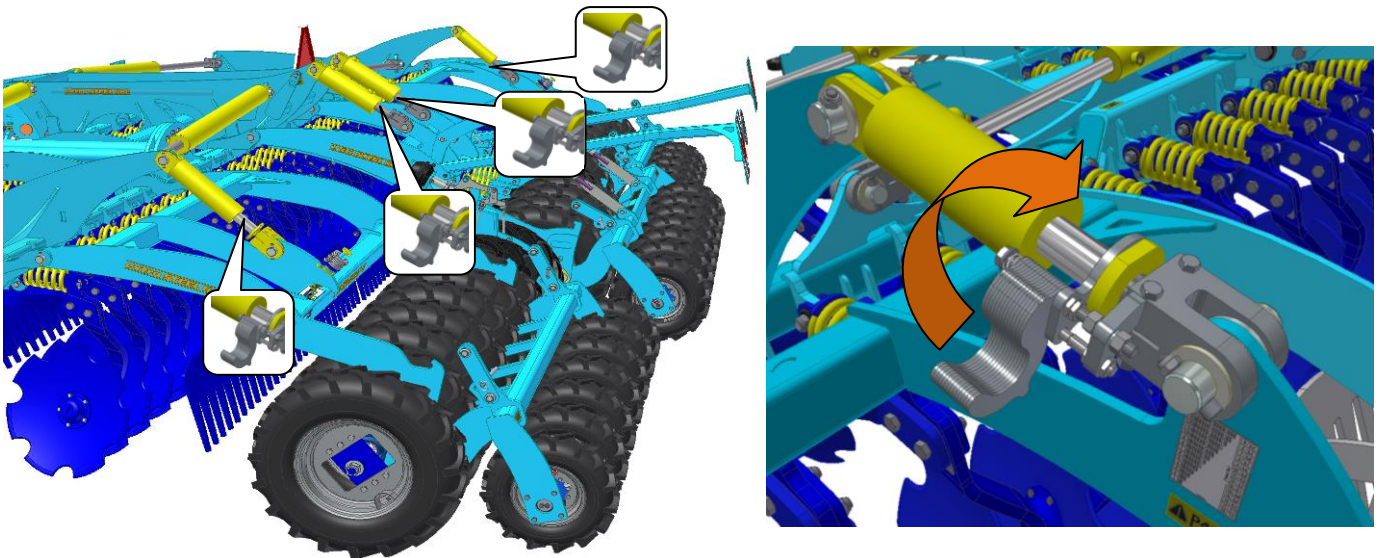

Fig. 3b – Adjusting machine with pole in the fixed tractor hitch



5.1 MACHINE WORKING DEPTH ADJUSTMENT ON ROLLERS

- Setting of soil processing depth is executed on lifted machine through adding or removing of distance washers on hydraulic cylinders.



- **The same combination of washers (number and force) must be set on all piston rods!!!**
- The chart on the machine specifies the individual operating positions and combinations of the distance washers.
- Specified working depths at individual positions are only for information. They may vary according to particular soil conditions. Required number of distance washers may be added/removed as needed.

5.2 SETTING THE LONGITUDINAL PLANE OF THE MACHINE

Using the TPS arms of the tractor, or the spacers on the piston-rods of the drawbar, set the machine so that the discs of the front and rear row work at the same depth.

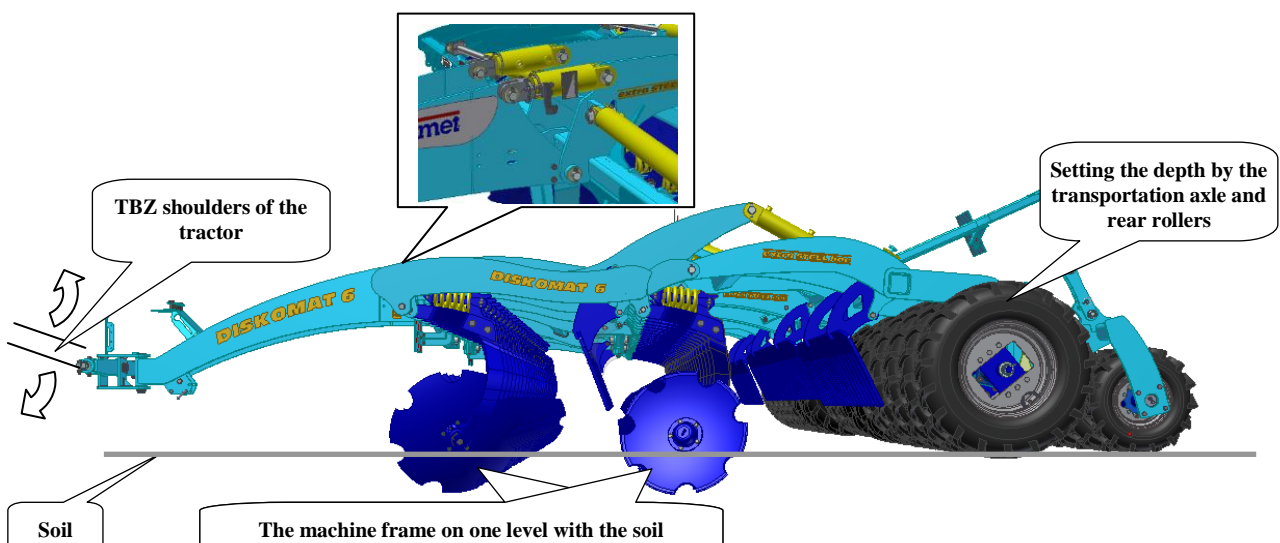

The machine features high stability during operation. However turning of machine to one side may occur with fault adjusted longitudinal plane (particularly in heavy soils). This is removed by modification of tractor arm height as follows, or by adding or removing the spacers on the piston-rods of the drawbar of the machine.

When the machine turns to the left-hand side, lift the machine in arms, or add spacers on the piston-rods of the drawbar.

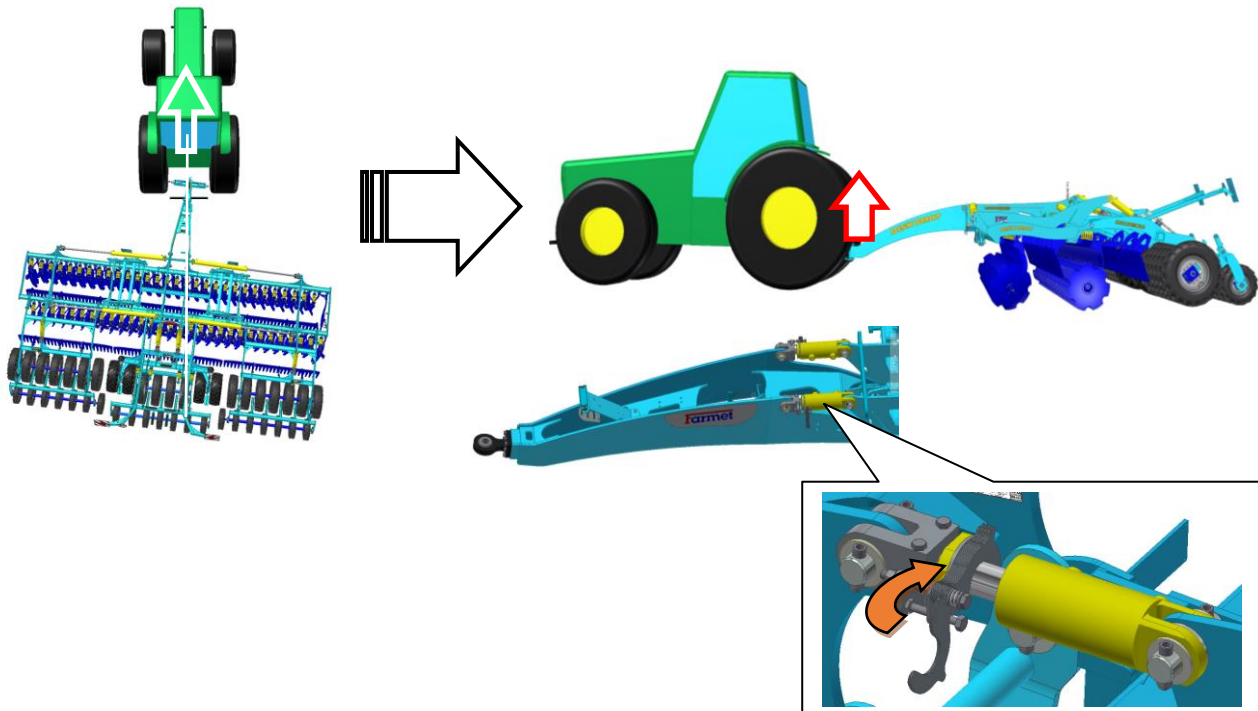

When the machine turns to the right-hand side, lower the machine in arms, or remove spacers on the piston-rods of the drawbar.

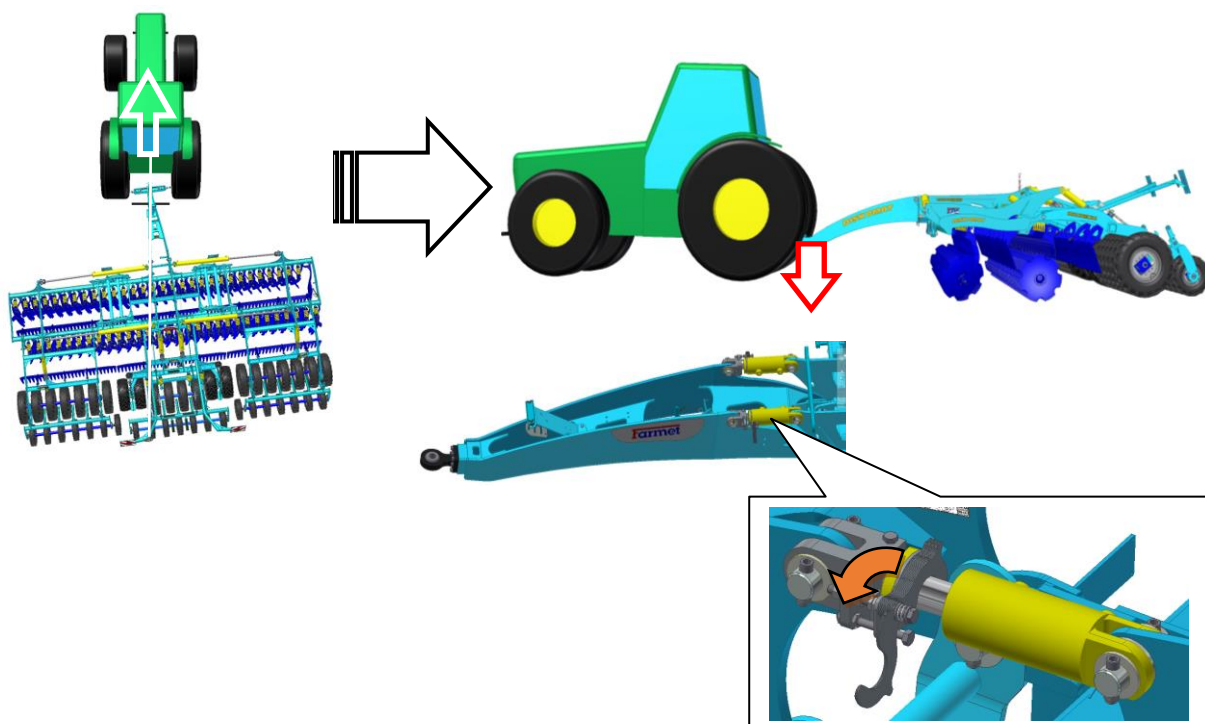

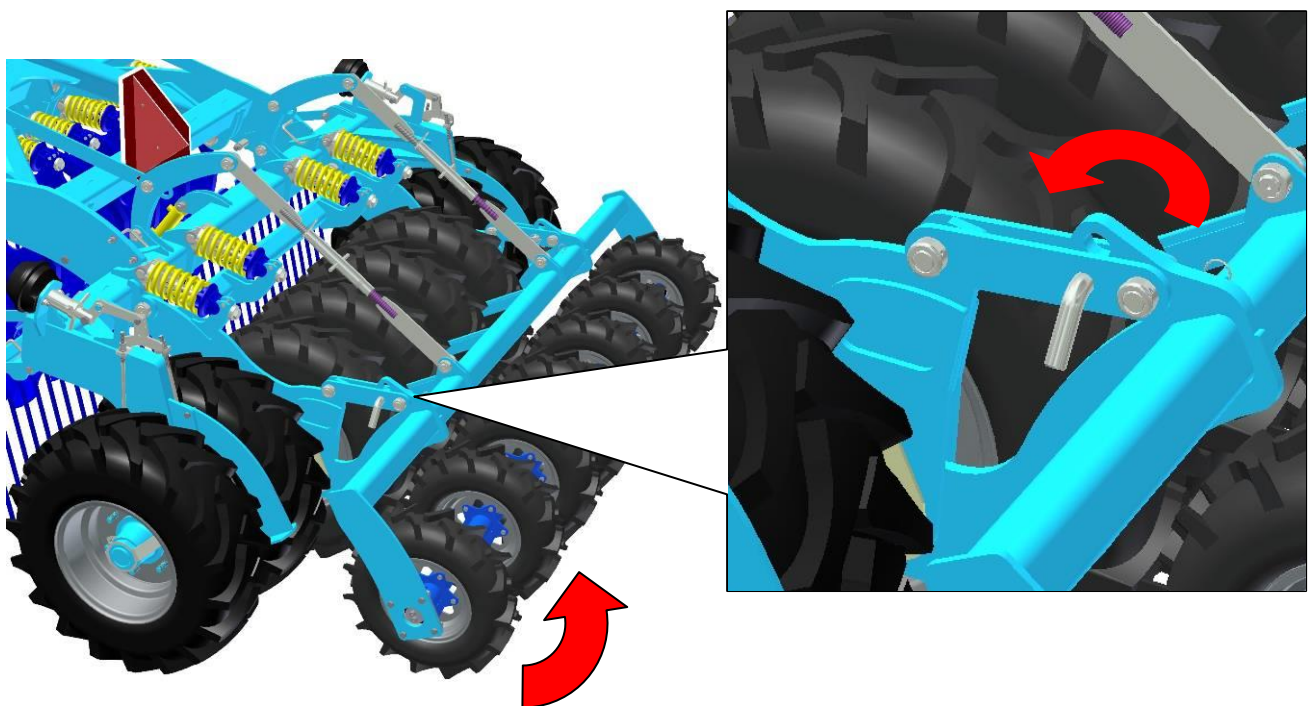
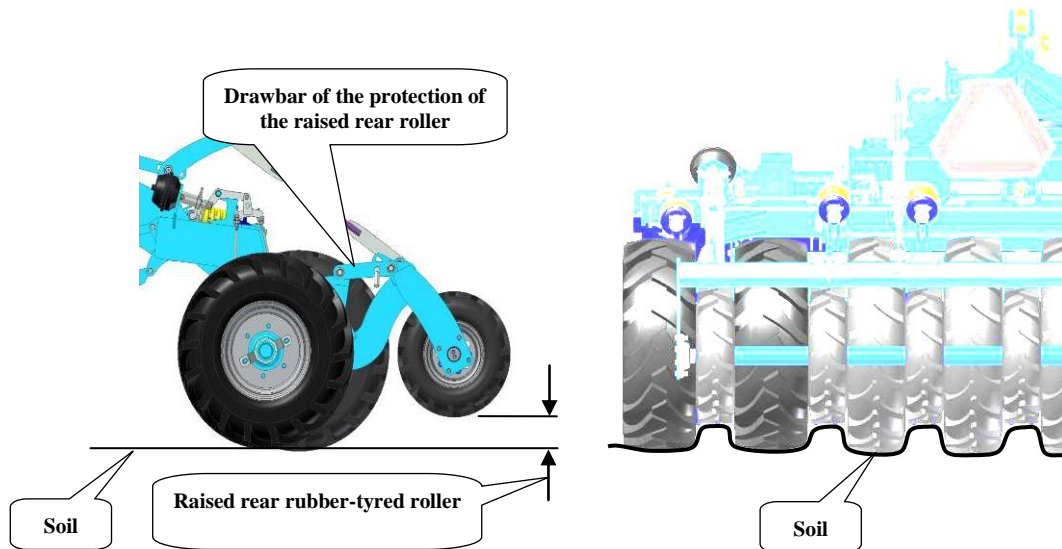

5.3 EXCLUSION OF REAR RUBBER-TYRED ROLLERS

- Raising the rear rubber-tyred rollers is important for the preparation of soil for winter.
- By raising the rear rubber-tyred rollers, you will ensure the formation of ridges: the soil surface remains undulating after the machine passes over it which creates a large area that positively influences faster drying of the soil in spring.
- The rear roller can be secured when the machine is fully lifted on the rubber-tyred rollers and on the tractor hydraulics, or the machine lifted on pneumatic rollers and the drawbar hydraulics. When the machine is lifted in this way, the rear rubber-tyred rollers can be simply secured by changing the position of the rear roller rod. The rear rubber-tyred rollers secured in this way will be lifted above the soil when the machine is recessed and the soil will only be compacted by the front rollers.



6. MACHINE MAINTENANCE AND REPAIRS

 **Observe the safety instructions for treatment and maintenance.**

- If it is necessary to weld during the repair and have the machine connected to the tractor, it must have disconnected supply cables from the alternator and the accumulator.
- Check the tightening of all screw and other assembly connections at the machine before every use of the machine, furthermore continuously as needed.
- Continuously check the wear of the working bodies of the machine, possibly replace these worn working bodies with new ones.
- Adjustment, cleaning, and lubrication of the machine may only be performed with the machine at rest (i.e. the machine is standing and not working).
- When working on a lifted machine, use suitable support equipment supported at marked points or at points suitable for that.
- During adjustment, cleaning, maintenance, and repair of the machine, you must secure those parts of the machine that could endanger the operator by falling or another movement.
- For catching the machine during handling using lifting equipment, use only the places marked with self-adhesive labels with the chain sign "  ".
- Upon a failure or damage of the machine, immediately turn off the tractor's engine and secure against restarting, secure the machine against movement \Rightarrow only then you can remove the failure.
- During repairs of the machine, use exclusively the genuine spare parts, suitable tools and protective equipment.
- Regularly check the prescribed pressure in the machine tyres and the condition of the tyres. Perform possible repairs of the tyres in an expert workshop.
- Keep the machine clean.



Do not clean hydraulic cylinders and bearings with a high-pressure cleaner or direct water stream. The seals and bearings are not watertight at high pressure.

Tightening and securing the disc bearings

First of all, tighten the screw nut and move the block around so that the bearings fit in the block. After that release the screw nut and tighten it again by 32Nm pulling torque. Furthermore, the screw nut has to be secured by snapping it into the shaft groove.

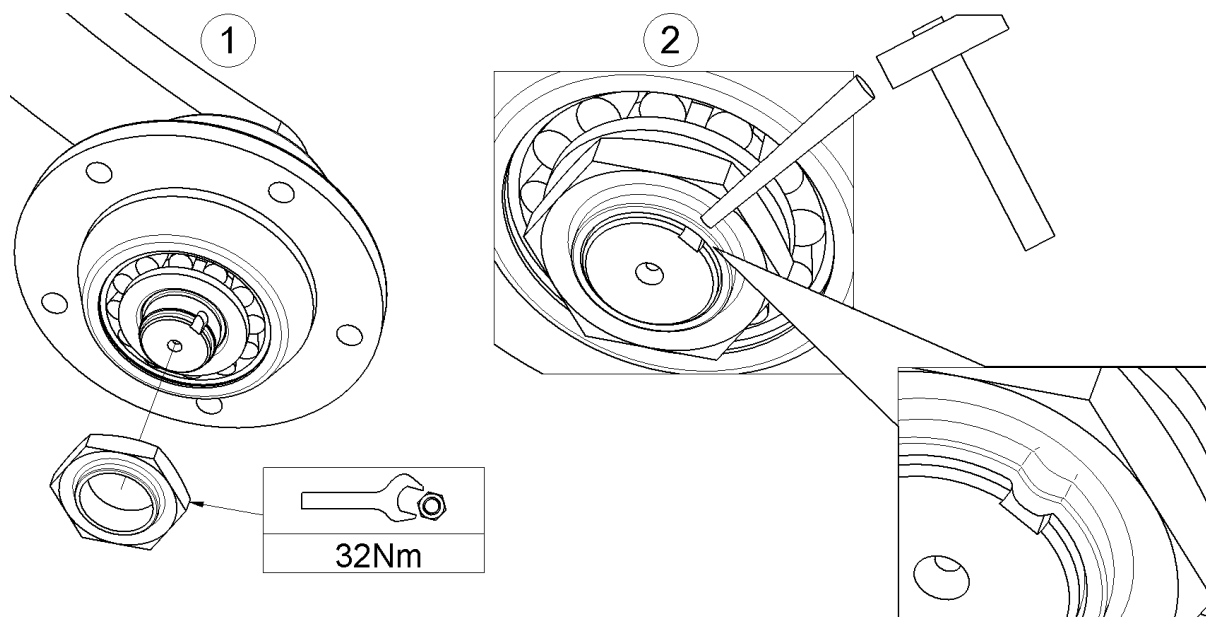

7. MACHINE STORAGE

Long-term machine shutdown:

- Store the machine under a roof if possible.
- Store the machine on a flat and solid surface with sufficient load capacity.
- Clean the machine before storing and conserve so that it is not damaged in any way during storage. Pay special attention to all marked lubrication points and properly lubricate them according to the lubrication plan.
- Store the machine in the position with folded frames in the transport position. Store the machine on the axle and the storage leg, secure the machine against spontaneous movement using scotches or another suitable tool. When storing, lower the machine into the lower position using hydraulics.
- The machine must not lean on the discs as the working discs of the machine could be damaged.
- Secure the machine against access of unauthorised persons.

8. MACHINE LUBRICATION SCHEDULE

- During machine maintenance and its lubrication, it is necessary to observe the safety regulations.

Table 4 – Locations and Intervals of the Machine Lubrication

LUBRICATION POINT		INTERVAL	LUBRICANT
Tow bar joint	Fig.4	- Daily, always before the work with the machine.	Plastic grease KP2P-20 Likx dle DIN 51 502
Rubber-tyred rollers bearings	Fig.6	- Always after the end of the season and before storing the machine	
Disc bearings	Fig.5	- Always after the end of the season and before storing the machine	

* Bearings are not lubricated if you have the maintenance-free version of disc and roller bearings

Fig. 4 - Tow bar joint

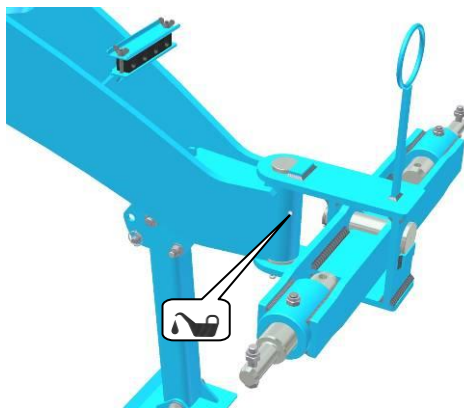

Fig. 5 - disc bearings

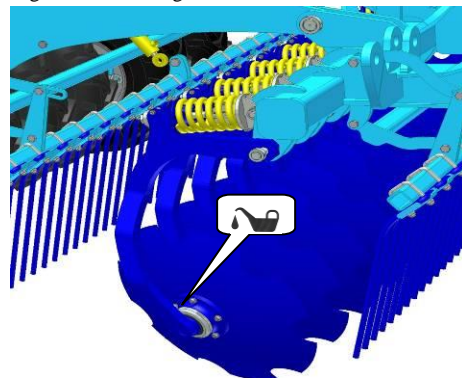
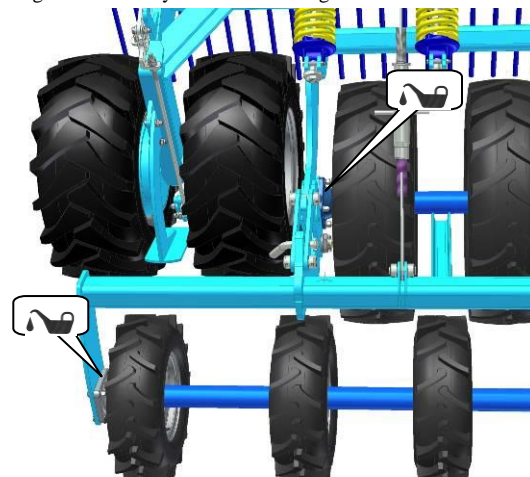

Fig. 6 – Rubber-tyred rollers bearings



Lubricant handling:

Protect yourselves against direct contact with oils by using gloves or protective creams. Thoroughly wash oil spots on the skin using warm water and soap. Do not clean the skin with petrol, engine diesel fuel or other solvents.

Oil is poisonous. If you swallowed the oil, immediately seek a physician.

- Protect the lubricants against children.

9. ENVIRONMENTAL PROTECTION

- Regularly check the tightness of the hydraulic system.
- Preventively replace or repair hydraulic hoses, possibly further parts of the hydraulic system showing signs of damage, before oil leaks occur.
- Check the condition of hydraulic hoses and perform their timely replacement. The service life of hydraulic hoses includes the time, when they were stored.
- Handle oils and greases according to valid waste laws and regulations.

10. MACHINE DISPOSAL AFTER SERVICE LIFE EXPIRY

- The operator must secure during machine disposal that steel parts and parts, in which hydraulic oil or lubricating grease moves are differentiated.
- Steel parts must be cut by the operator while observing safety regulations and handed over to the secondary raw material collection point. He must proceed with other parts according to valid laws about waste.

11. SERVICING AND WARRANTY CONDITIONS

11.1 SERVICING

Servicing is secured by the dealer after consulting with the manufacturer, possibly directly by the manufacturer. Spare parts then using the sales network by individual sellers in the entire country. Use only the spare parts according to the spare parts catalogue officially issued by the manufacturer.

11.2 WARRANTY

- 11.2.1** The manufacturer provides a warranty of 24 months for these machine parts: main frame, axle, and machine tow bar. For other parts of the machine, the manufacturer provides a warranty of 12 months. The warranty is provided from the date of sale of the new machine to the end user (consumer).
- 11.2.2** The warranty applies to hidden defects that will show in the warranty period with proper use of the machine and while fulfilling the conditions stated in the operating manual.
- 11.2.3** The warranty does not apply to wearable spare parts, i.e. regular mechanical wear and tear of replaceable parts of the working sections (shares, edges, etc.).
- 11.2.4** The warranty does not apply to indirect consequences of possible damage, such as service life decrease etc.
- 11.2.5** The warranty is bound to the machine and is not void upon an owner change.
- 11.2.6** The warranty is limited to the disassembly and assembly, possibly replacement or repair of the defective part. The decision, whether to replace or repair the defective part, is up to the contractual workshop of Farmet.
- 11.2.7** During the warranty period, only the authorised servicing technician of the manufacturer may perform repairs or other interventions into the machine. In the opposite case, the warranty will not be acknowledged. This provision does not apply to the replacement of wearable spare parts (see point 11.2.3).
- 11.2.8** The warranty is conditioned by using the genuine spare parts of the manufacturer.

Farmet a. s.
Jiřinková 276
ČESKÁ SKALICE 552 03



Tel.: +420 491 450 140
Fax.: +420 491 450 136
GSM.: +420 774 715 738

LETTER OF GUARANTEE

MACHINE TYPE:

PRODUCTION YEAR/PRODUCTION NUMBER: _____

CHECK CONFIRMATION: _____

ADDRESS (BUYER): _____

ADDRESS (SELLER): _____

WARRANTY CONDITIONS:

- I. The manufacturer provides a warranty of 24 months for these machine parts: main frame, axle, and machine tow bar. For other parts of the machine, the manufacturer provides a warranty of 12 months. The warranty is provided from the date of sale of the new machine to the end user (consumer).
- II. The warranty applies to hidden defects that will show in the warranty period with proper use of the machine and while fulfilling the conditions stated in the operating manual.
- III. The warranty does not apply to wearable spare parts, i.e. regular mechanical wear and tear of replaceable parts of the working sections (shares, etc.).
- IV. The warranty does not apply to indirect consequences of possible damage, such as service life decrease etc.
- V. The warranty is bound to the machine and is not void upon an owner change.
- VI. The warranty is limited to the disassembly and assembly, possibly replacement or repair of the defective part. The decision, whether to replace or repair the defective part, is up to the contractual workshop of Farmet.
- VII. During the warranty period, only the authorised servicing technician of the manufacturer may perform repairs or other interventions into the machine. In the opposite case, the warranty will not be acknowledged. This provision does not apply to the replacement of wearable spare parts (see point III).
- VIII. The warranty is conditioned by using the genuine spare parts of the manufacturer.

PRODUCTION PLANT
CONFIRMATION

SELLER CONFIRMATION

DATE

FIRST SALE DATE

ⒸES PROHLÁŠENÍ O SHODĚ
ⒸCE CERTIFICATE OF CONFORMITY
ⒸEG-KONFORMITÄTSEKTLÄRUNG
ⒸDÉCLARATION CE DE CONFORMITÉ
ⒸСЕРТИФИКАТ СООТВЕТСТВИЯ ЕС
ⒸDEKLARACJA ZGODNOŚCI WE

1. ⒸMy ⒸWe ⒸWir ⒸNous ⒸМы ⒸMy: **Farmet a.s.**
Jiřinková 276
552 03 Česká Skalice
Czech Republic
DIČ: CZ46504931
Tel/Fax: 00420 491 450136

ⒸVydáváme na vlastní zodpovědnost toto prohlášení. ⒸHereby issue, on our responsibility, this Certificate. ⒸGeben in alleiniger Verantwortung folgende Erklärung ab. ⒸPublions sous notre propre responsabilité la déclaration suivante. ⒸПод свою ответственность выдаем настоящий сертификат. ⒸWydajemy na własną odpowiedzialność niniejszą Deklarację Zgodności.

2. ⒸStrojní zařízení: - název : **Diskový podmítač**
ⒸMachine: - name : **Disk plough-harrow**
ⒸFabrikat: - Bezeichnung : **Kurzscheibenegge**
ⒸMachinerie: - dénomination : **Déchaumeur à disques**
ⒸСельскохозяйственная машина: - наименование : **Дисковый луцильник**
ⒸUrządzenie maszynowe: - nazwa : **Talerzowy plug podorywkowy**

- typ, type : **DISKOMAT**
- model, modèle : **DISKOMAT 5; 6; 8**
- Ⓒvýrobní číslo :
- Ⓒserial number
- ⒸFabriknummer
- Ⓒn° de production
- Ⓒзаводской номер
- Ⓒnumer produkcyjny:

3. ⒸPříslušná nařízení vlády: č.176/2008 Sb. (směrnice 2006/42/ES). ⒸApplicable Governmental Decrees and Orders: No.176/2008 Sb. (Directive 2006/42/ES). ⒸEinschlägige Regierungsverordnungen (NV): Nr.176/2008 Slg. (Richtlinie 2006/42/ES). ⒸDécrets respectifs du gouvernement: n°.176/2008 du Code (directive 2006/42/CE). ⒸСоответствующие постановления правительства: № 176/2008 Сб. (инструкция 2006/42/ES). ⒸOdpowiednie rozporządzenia rządowe: nr 176/2008 Dz.U. (Dyrektywa 2006/42/WE).

4. ⒸNormy s nimiž byla posouzena shoda: ⒸStandards used for consideration of conformity: ⒸDas Produkt wurde gefertigt in Übereinstimmung mit folgenden Normen: ⒸNormes avec lesquelles la conformité a été évaluée: ⒸНормы, на основании которых производилась сертификация: ⒸNormy, według których została przeprowadzona ocena: ČSN EN ISO 12100, ČSN EN ISO 4254-1.

ⒸSchválil ⒸApprove by dne: 06.01.2012
ⒸBewilligen ⒸApprouvé
ⒸУтвердил ⒸUchwalil

V České Skalici dne: 06.01.2012

p. Gavlas Dušan
technický ředitel
Technical director

Farmet a.s.
Jiřinková 276
552 03 Česká Skalice
DIČ CZ46504931
38

Ing. Karel Žďárský
generální ředitel společnosti
General Manager

