

# OPERATING MANUAL

# **DISKOMAT**

**3 N | 3,5 N**

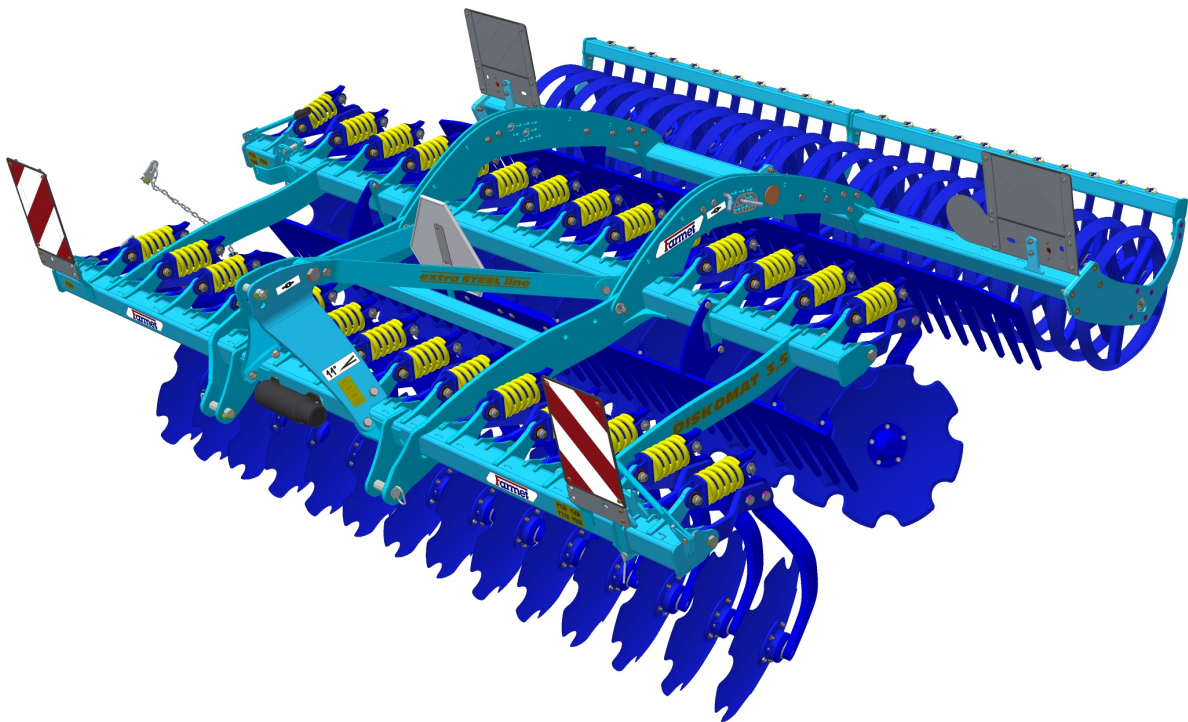

Edition: **2** Effective from: **01.11.2016**

FARMET a.s.  
Jiřinková 276  
552 03 Česká Skalice, CZ

phone: +420 491 450 111  
fax: +420 491 450 136  
GSM: +420 774 715 738

IČ: 46504931  
DIČ: CZ46504931

www.farmet.cz  
e-mail: farmet@farmet.cz

**Prepared by: Technical Department, Farmet a.s.**  
on 20.08.2018, changes reserved

## PREFACE

Dear customer,

The agricultural machine you have purchased is a high-quality product of Farmet a.s. Česká Skalice.

You can fully utilise the advantages of your machine after thoroughly studying the operating manual.

The serial number of the machine is punched on the production label and written in the operating manual (Your Machine Characteristics). This machine serial number must be stated whenever ordering spare parts for possible repairs. The production label is located on the frame.

Use only spare parts for these machines according to the **Spare parts catalogue** officially issued by the manufacturer, Farmet a.s. Česka Skalice.

### POSSIBILITIES OF USE OF YOUR MACHINE

The **DISKOMAT** disc plough-harrow is intended for ploughing all types of soil up to the depth of 18 cm (7,1 in).

### YOUR MACHINE CHARACTERISTICS

MACHINE TYPE :

MACHINE SERIAL NUMBER :

SPECIAL DESIGN OR ACCESSORIES :

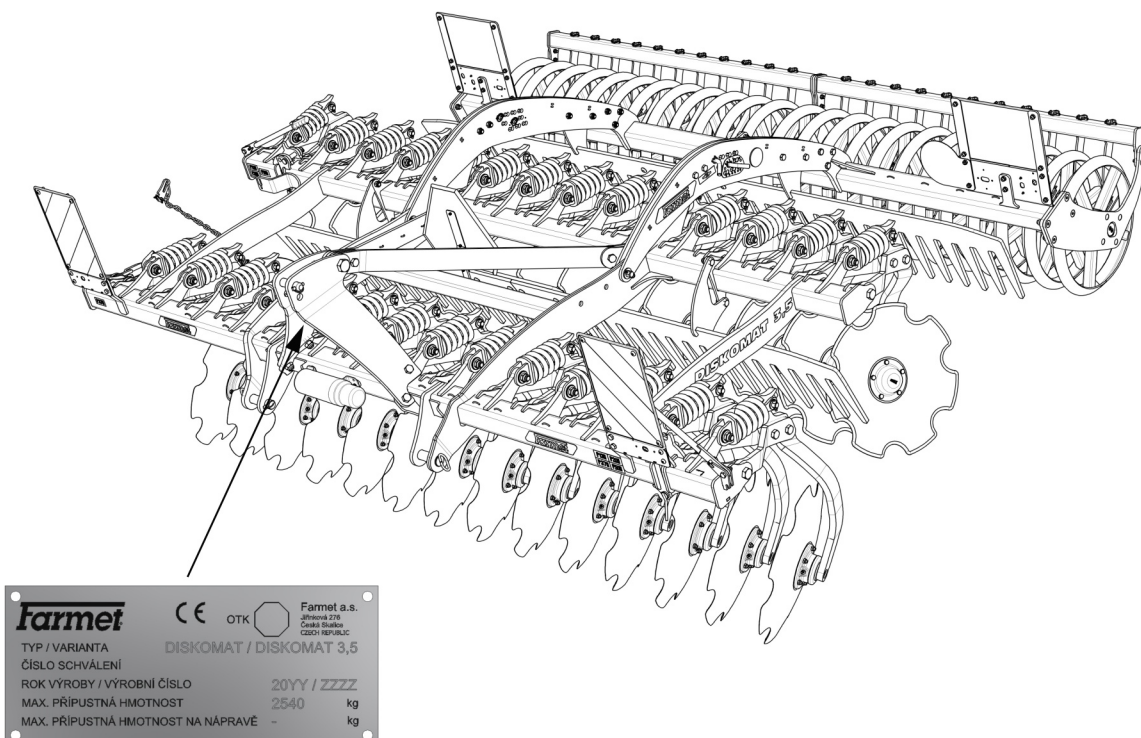
**IMPORTANT**

**READ CAREFULLY BEFORE USE**

**KEEP FOR FUTURE REFERENCE**

---

## Contents

PREFACE .....	3
1 MACHINE LIMIT PARAMETERS .....	7
1.1 Technical parameters.....	8
1.2 Safety statement.....	8
2 GENERAL INSTRUCTIONS FOR USE .....	9
3 MACHINE TRANSPORT USING TRANSPORT MEANS .....	11
4 MACHINE HANDLING USING LIFTING EQUIPMENT .....	12
5 WORK SAFETY LABELS .....	13
6 DESCRIPTION.....	16
6.1 Working parts of the machine .....	16
7 MACHINE ASSEMBLY AT THE CUSTOMER.....	17
8 COMMISSIONING.....	18
8.1 Agregation to a tractor .....	19
9 MACHINE TRANSPORT ON ROADS.....	20
10 MACHINE ADJUSTMENT .....	22
10.1 Adjusting the working depth of the machine .....	22
10.2 Machine adjustment using tractor's TPS arms .....	23
10.3 Setting the side deflector.....	23
10.4 Fixing the position of the roller.....	24
11 MACHINE MAINTENANCE AND REPAIRS.....	25
11.1 Tightening and securing the disc bearings (does not apply to maintenance-free bearings) .....	25
12 MACHINE STORAGE.....	26
13 MACHINE LUBRICATION SCHEDULE .....	27
14 ENVIRONMENTAL PROTECTION .....	28
15 MACHINE DISPOSAL AFTER SERVICE LIFE EXPIRY.....	29
16 SERVICING AND WARRANTY CONDITIONS .....	30
16.1 Servicing .....	30
16.2 Warranty .....	30



## 1 MACHINE LIMIT PARAMETERS

- The machine is designed for soil ploughing up to a depth of 18 cm (7,1 in) when agricultural soil cultivation. Another type of use exceeding the determined purpose is forbidden.
- Machine operation is performed by one person – the tractor driver.
- Machine operator must not use the machine in a different way, especially:
  - Transport of persons and animals on the machine structure,
  - Transport of burdens on the machine structure,
  - Aggregation of the machine with another towing equipment than stated in Chapter 8.1.

## 1.1 Technical parameters

PARAMETERS		DISKOMAT 3 N	DISKOMAT 3,5 N
Working width		3 m (9,84 ft)	3,5 m (11,48 ft)
Transport width		3 m (9,84 ft)	
Transport height		2,2 m (7,22 ft)	
Machine total length		3,25 m (10,66 ft)	
Working depth		6 – 18 cm (2,4 – 7,1 in)	
Number of discs $\varnothing$ 620 mm ( $\varnothing$ 24,4 in)	front	12	14
	rear	12	14
Working performance		5 – 7,5 ha/h (12,4 – 18,5 ac/h)	6 – 9 ha/h (14,8 – 22,2 ac/h)
Towing means		105 – 158 kW (140 - 215 HP)*	120 – 180 kW (160 – 240 HP)*
Working speed		10 – 15 km/h (6 – 9,5 mph)	
Maximum transport speed		25 km/h (15 mph)	
Maximum slope grade		6 (°)	
Machine weight		2 400 kg (5 300 lb)	2 600 kg (5 750 lb)

\*Recommended towing means, the real towing force may significantly vary according to the processing depth, soil conditions, land slope, working body wear and adjustment.

## 1.2 Safety statement



This warning sign warns about an immediate dangerous situation ending with death or severe injury.





This warning sign warns about a dangerous situation ending with death or severe injury.



This warning sign warns about a situation that may end with a smaller or slight injury. It also warns about dangerous actions related to the activity that could lead to an injury.



## 2 GENERAL INSTRUCTIONS FOR USE

- The machine is made in accordance with the latest equipment state and approved safety regulations. However, dangers of user or third person injury or machine damage or creation of other material damage may arise during use.
- Use the machine only in a technically sound condition, in accordance with its purpose, aware of possible dangers, and while adhering to the safety instructions of this operating manual !!!  
The Manufacturer is not liable for damages caused by the use of the machine that is in contradiction with the limit parameters of the machine and with the instructions for the use of the machine (Chapter 2 and 8). The User bears the risk.  
Immediately remove especially the failures that may negatively affect safety!
- Machine operation may be performed by a person authorised by the operator under these conditions:
  - It must own a valid driver's licence of the corresponding category,
  - It must be demonstrably familiarised with the safety regulations for work with the machine and must practically master the machine operation,
  - The machine may not be operated by juveniles,
  - It must know the meaning of the safety signs located on the machine. Their respecting is important for safe and reliable machine operation.
- Maintenance and servicing repairs on the machine may only be performed by a person :
  - Authorised by the operator,
  - Educated in the machinery field with knowledge of repairs of similar machines,
  - Demonstrably familiarised with safety regulations for work with the machine,
  - During a repair of a machine connected to a tractor, it must own a driver's licence of the corresponding category.
- Machine operator must secure the safety of other persons when working with the machine or transporting the machine.
- During machine work in the field or during transport, the operator must control the machine from the tractor's cabin.
- The operator may enter the machine structure only with the machine at rest and blocked against movement, namely only for these reasons:
  - Adjustment of the machine working parts,
  - Repair and maintenance of the machine,
-  When stepping on the machine, do not step on roller tyres, discs or other rotary parts. Those may turn and you can cause very serious injuries by the subsequent fall.
-  Any changes or modifications of machine may be performed only with written consent of the manufacturer. For possible damage arisen due to ignoring this instruction, the producer bears no responsibility. The machine must be maintained equipped with prescribed accessories and equipment including safety marking. All warning and safety signs must be legible and in their places. In case of damage or loss, these signs must be immediately renewed.
- The operator must have the Operating Manual with the work safety requirements available at any time when working with the machine.



- The operator must not consume alcohol, medicines, narcotic and hallucinogenic substances that decrease his attention and coordination capabilities while using the machine. If the operator must use medicines prescribed by a physician or uses freely sold medicines, he must be informed by a physician, whether he is capable of responsible and safe operation of the machine under these circumstances.

**Protective equipment :**

For operation and maintenance, you need :



- Tight clothes
- Protective gloves and goggles for protection against dust and sharp parts of the machine



### 3 MACHINE TRANSPORT USING TRANSPORT MEANS

- The transport means designed for machine transport must have the load capacity minimally identical with the weight of the transported machine. The total weight of the machine is stated on the production label.
- The dimensions of the transported machine including the transport means must comply with the valid regulations for road traffic (decrees, laws).
-  • The transported machine must be always fastened to the transport means so that its spontaneous loosening could not happen.
- The carrier is responsible for damage caused by the loosening of incorrectly or insufficiently fastened machine to the transport means.

## 4 MACHINE HANDLING USING LIFTING EQUIPMENT

- The lifting equipment and tying means designed for handling of the machine must have their load capacity at least identical with the weight of the handled machine.
-  • Machine fastening for handling may only be performed in places designed for that and marked with self-adhesive labels showing the "chain" symbol. 
- After fastening (suspending) at designated points, it is forbidden to move in the space of possible reach of the handled machine.

## 5 WORK SAFETY LABELS

Warning safety labels serve for operator protection.

**General:**

- Strictly observe the warning safety labels.
- All safety instructions also apply to other users.
- Upon damage or destruction of the aforementioned "SAFETY LABEL" located on the machine, THE OPERATOR IS OBLIGED TO REPLACE IT WITH A NEW ONE!!!
- The position, appearance, and precise meaning of work safety labels on the machine is determined in the following tables and in the figure (Fig. 1).

WARNING SAFETY LABEL	LABEL TEXT	MACHINE POSITION
	<p>Before handling the machine, carefully read the operating manual. Observe the instructions and safety regulations for machine operation during use.</p>	<b>P 1 H</b>
	<p>When connecting or disconnecting, do not step between the tractor and the machine, also do not enter this space, if the tractor and the machine are not at rest and the engine is not turned off.</p>	<b>P 2 H</b>
	<p>Stay outside the reach of the tractor - agricultural machine set, if the tractor engine is in operation.</p>	<b>P 6 H</b>
	<p>Before commencing the machine transport, secure the axle with spherical valves against unexpected drop. (DSK 5 - 8 PS)</p>	<b>P 13 H</b>
	<p>When folding the side frames, do not reach into the space of the machine folding joints. There is a danger of cutting when setting the depth of the machine.</p>	<b>P 20 H</b>
	<p>Travelling and transport on the machine structure is strictly forbidden.</p>	<b>P 37 H</b>





	<p>When working and transporting the machine, maintain safe distance from the electric appliances. (DSK 5 – 8 PS)</p>	<p><b>P 39 H</b></p>
	<p>When folding and unfolding the side frames, stay outside their reach.</p>	<p><b>P 50 H</b></p>
	<p>Secure the machine against unwanted movement by positioning on its working bodies (discs). U strojů DSK 5 – 8 PS zajistěte kola nápravy podkládacími klíny.</p>	<p><b>P 52 H</b></p>
	<p>Do not approach the rotary parts of the machine, if these are not at rest, i.e. they do not turn.</p>	<p><b>P 53 H</b></p>
	<p>It is strictly folding and unfolding the side frames on slopes or inclined surfaces.</p>	<p><b>P 100 H</b></p>
	<p>The shown positions of the lever and the function of the hydraulic spherical valve located on the piston rod. (DSK 5 – 8 PS)</p>	<p><b>P 101 H</b></p>

Fig. 1 - Location of safety labels on the machine

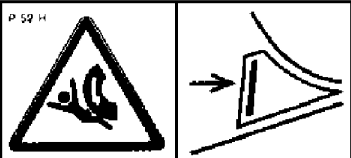
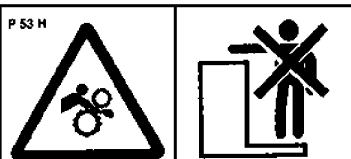

## 6 DESCRIPTION

The **DISKOMAT 3**, **DISKOMAT 3,5** machines are designed as carried with a three-point linkage of category TBZ 3.

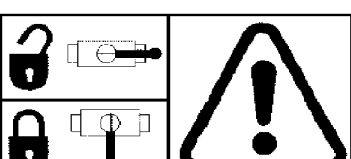
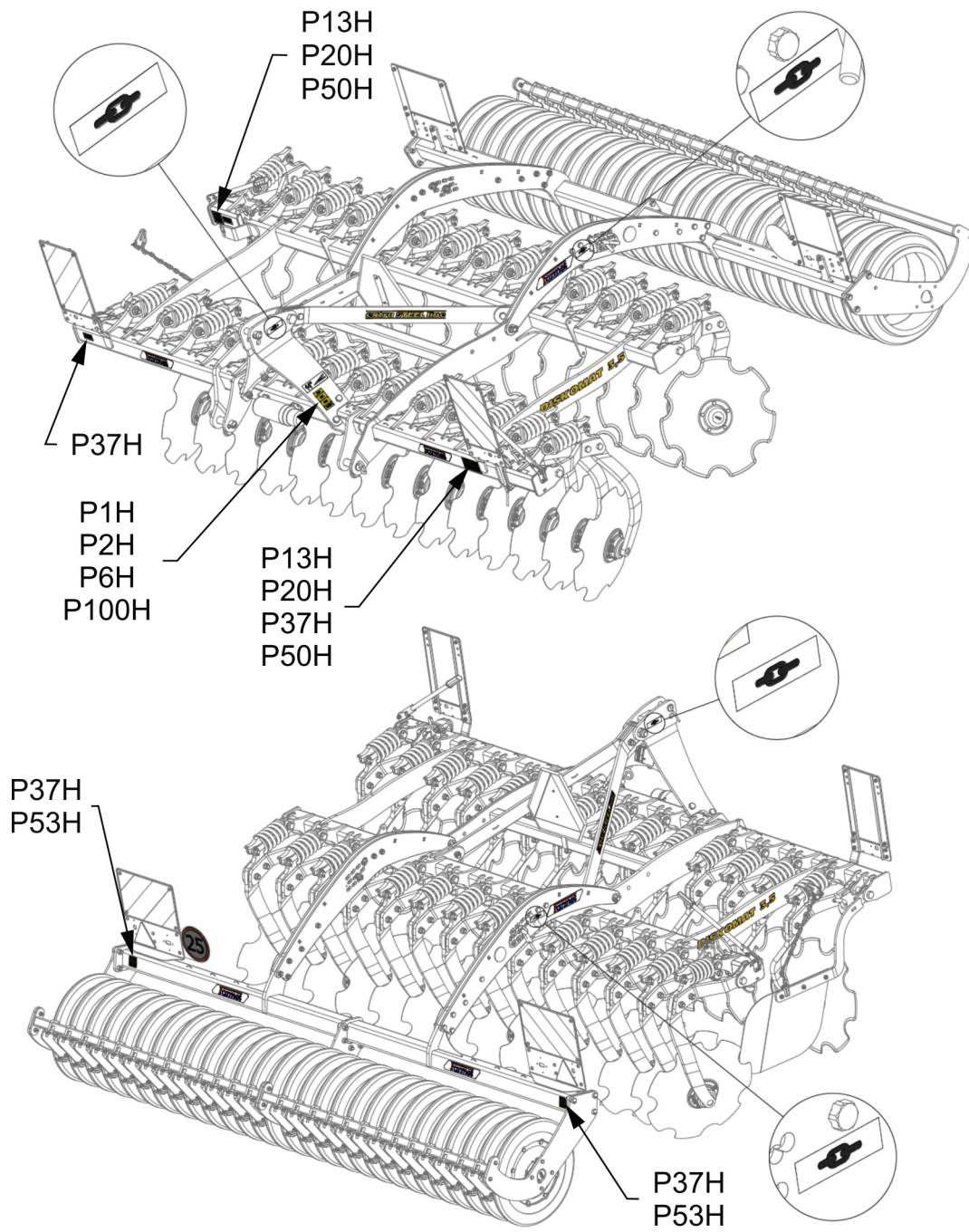
Diskomat consists of a frame that carries two rows of working discs with a diameter of 620 mm (Ø24,4 in) with automatic spring protection. There are deflectors directing and breaking flying soil located behind the front as well as the rear row of discs. There are rubber-tyred rollers in the rear that compact the loosened soil.

### 6.1 Working parts of the machine

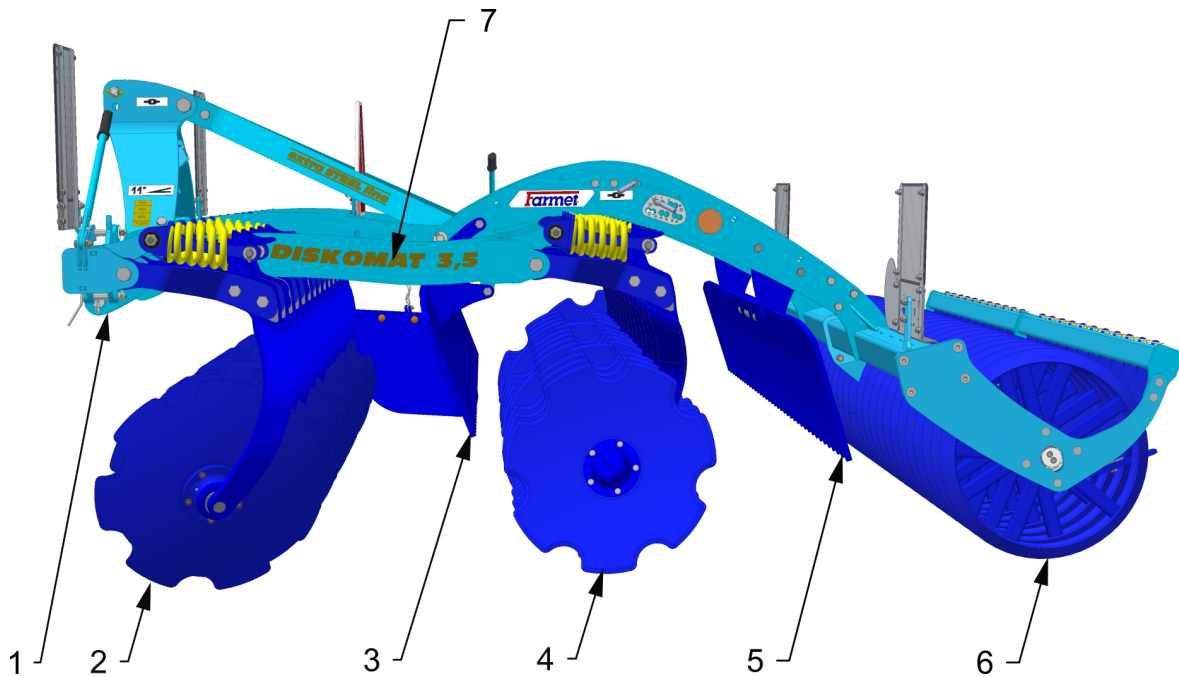

- 1 – Towing suspension
- 2 – Front disc row
- 3 – Front deflectors
- 4 – Rear disc row
- 5 – Rear deflectors
- 6 – Rear roller
- 7 – Central frame



## 7 MACHINE ASSEMBLY AT THE CUSTOMER

- The operator must perform the assembly according to the instructions of the producer, best in cooperation with the expert servicing technician determined by the producer.
-  • The operator must secure a functional test of all assembled parts after the completion of the machine assembly.
- The operator must secure that the handling of the machine using lifting equipment during its assembly is in accordance with chapter „4“.

## 8 COMMISSIONING

- Before taking over the machine, test and check, whether damage occurred during transport and whether all parts contained in the bill of delivery were supplied.



- Before commissioning the machine, carefully read this operating manual, especially Chapters 1–5. Before the first use of the machine, familiarise yourselves with its controls and overall function.
- During work with the machine, observe not only the instructions of this operating manual but also generally valid regulations of work safety, health protection, fire and transport safety, and environmental protection.
- The operator must check the machine before every use (commissioning) from the standpoint of completeness, work safety, work hygiene, fire safety, transport safety, and environmental protection. A machine showing signs of damage must not be commissioned.
- Aggregation of the machine with the tractor is to be performed on a flat and hardened surface.
- When working on slopes, observe the lowest allowable slope grade of the set **TRACTOR - MACHINE**.
- Before starting the tractor motor, check whether no person or animal is in the working space of the set and push the warning sound signal.
- The operator is responsible for the safety and all damage caused by the operation of the tractor and the connected machine.
- The operator is obliged to adhere to the technical and safety regulations of the machine determined by the producer when working.
- The operator is obliged to retract the working bodies of the machine from the ground when turning at the headland.
- The operator is obliged to observe the prescribed working depths and speeds stated in the manual in. chap.1.
- The operator is obliged to lower the machine to the ground and secure the set against movement before leaving the tractor cabin.

**DECREASE OF SOIL PRESSURE TO A VALUE LOWER THAN 200 KPA (29 PSI)**

To decrease the specific pressure on soil (lower than 200 kPa / 29 Psi) at the turns on the headland, raise the machine on the pole by using the hydraulic tractor shoulders and rear rollers. Turn around when the machine is unfolded and resting on rollers.

## 8.1 Agregation to a tractor

- The machine may only be connected to a tractor with a service weight and parameters allowing for safe work with the attached machine and its safe transportation on roads.
- The machine operator must observe all generally valid regulations of work safety, health protection, fire safety, and environmental protection.
- The operator may connect the machine exclusively to a tractor that is equipped with a rear three-point suspension and a functional undamaged hydraulic system.
- The table of requirements for the towing means for work with the machine:

Requirement for the tractor engine power for disc plough-harrow	<b>DISKOMAT 3 N</b>	<b>105 – 158 kW (140 – 215 HP)</b>
	<b>DISKOMAT 3,5 N</b>	<b>120 – 180 kW (160 – 240 HP)</b>
Requirement for the tractor's TPS	Spacing of the lower suspension joints (measured at the joint axes)	<b>1050±1,5 mm (41,34 in)</b>
	Øof the hole of the lower suspension joints for the machine suspension pivots	<b>37,5 mm (1,48 in)</b>

- Connect the machine using the TPS suspension to the lower arms of the rear TPS of the tractor, secure the TPS arms using pins against disconnecting.
- The machine aggregated with the tractor changes the distribution of the weight to the individual axles of the tractor. The weight of the front axle is reduced and therefore the controllability gets worse. It also affects braking properties.



**When connecting, no persons may stay in the space between the tractor and the machine.**

## 9 MACHINE TRANSPORT ON ROADS

### Transport Position of Machine

- Connect the machine by suspending on the tractor using the three-point suspension equipment (TPS 3).
- Fold the side discs on the main frame into the transport position.

Fold and unfold discs using the control lever (see the figure). When controlling the position of the disc, never stand under the disc – always stand on the side!!! Secure the disc position with a pin!

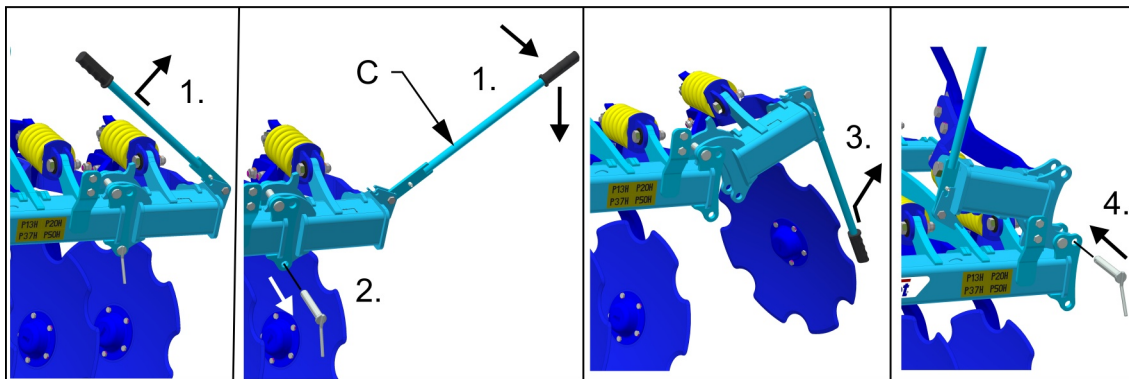
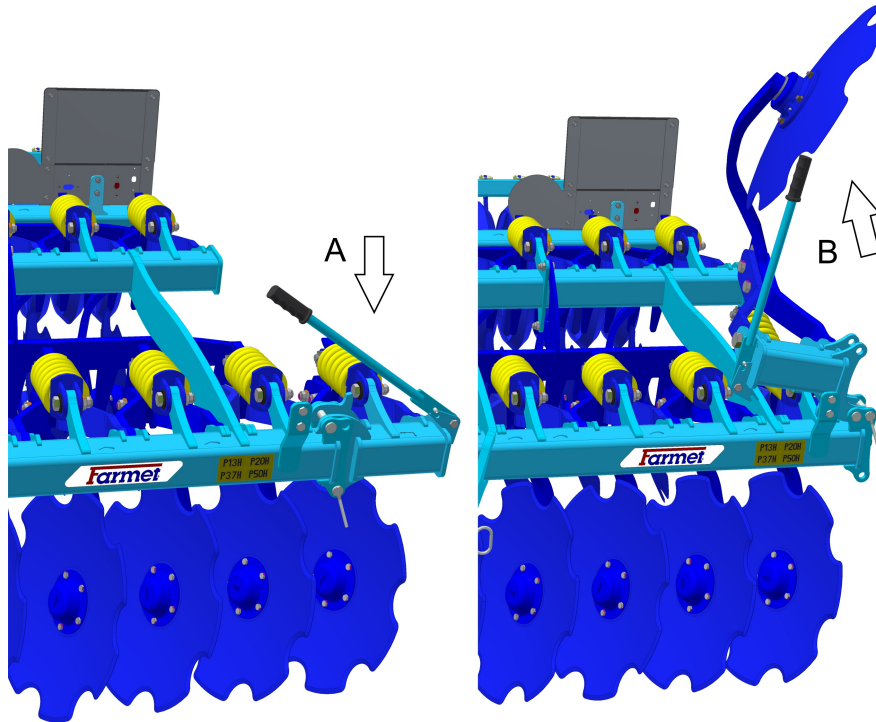

- A – Working position
- B – Transport position
- C – Control lever

- The side deflector must be folded into the machine for transport on roads. Set the deflector in the transport or working position using the pin.

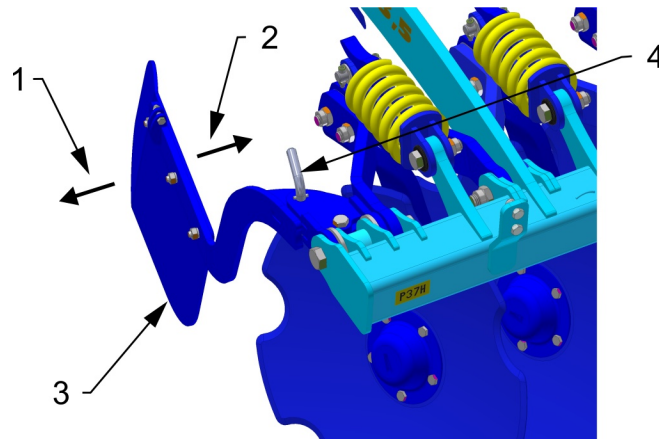

- 1 – Working position
- 2 – Transport position
- 3 – Side deflector
- 4 – Deflector securing pin

- Turn over the rear twin roller and secure it with the stopper - only if the machine is equipped with the rear twin roller.
- The machine must be equipped with removable shields with marking of contours, functional lighting, and the board of the rear marking for slow vehicles (according to ECE No. 69).
- The lighting must be activated during travelling on roads.
- The tractor must be equipped with a special light device of an orange colour, which must be activated during travelling on roads.
- The maximum transport speed during travelling on roads is **25 km/hod (15 mph)**.
- Secure the lower shoulders of the tractor TPS from side swing.



### Ban of transport with decreased visibility!

- Bring the machine into the transport position.
- The operator is obliged to pay increased attention during transport on roads, due to the transport dimensions of the machine.
- The operator must observe the valid regulations for transport on roads (laws, decrees) after connecting the machine to the tractor, for reason of a change of the axle load. The driving properties of the set also change depending on the terrain nature, adapt the manner of driving to these conditions.
- Only machines with a valid technical certificate issued in accordance with the valid regulation on the approval of technical qualification and operation on public communications as amended may be transported on public communications. Machines without a valid technical certificate may only be transported on public communications when carried by a towed trailer or other approved means of transport in accordance with the valid regulation.
- The operator is obliged to secure sufficient outlook during reversing from his position of the tractor driver. In case of insufficient outlook, the operator is obliged to call a competent and informed person.
- The operator must secure the arms of the rear TPS of the tractor in the transport position during road transport, i.e. prevent unexpected arm drop using the hydraulic arm control lever. At the same time, the arms of the rear TPS of the tractor must be secured against side swinging.
- During machine transport on roads, the operator must observe the valid laws and decrees that deal with this topic and which specify the relationships of the tractor axle load depending on transport speed.

## 10 MACHINE ADJUSTMENT

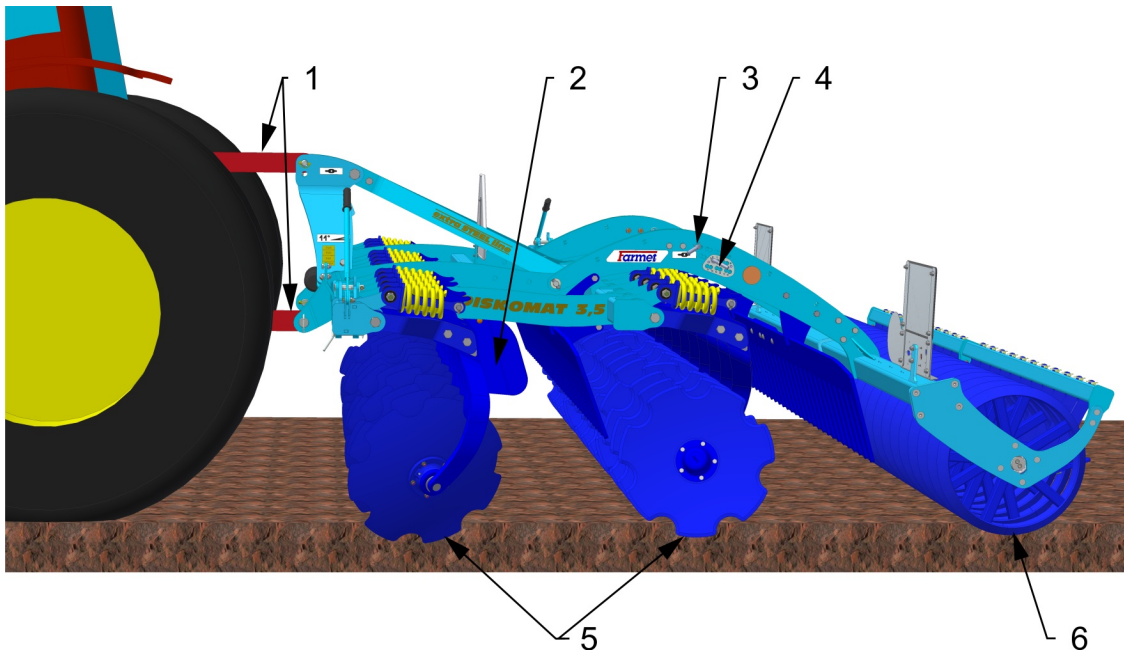

- 1 – Setting the lengthwise level
- 2 – Setting the side deflector
- 3 – Roller fixture
- 4 – Setting the working depth
- 5 – Discs – processing depth
- 6 – Rear roller

### 10.1 Adjusting the working depth of the machine

- Set the working depth using the bottom pin on the rear roller frame gate according to the scale (6 – 18 cm / 2,4 – 7,1 in)

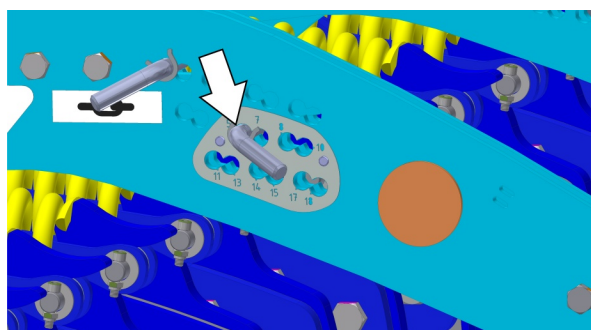

## 10.2 Machine adjustment using tractor's TPS arms

- Set the lengthwise level of the machine by positioning the lower arms of the tractor and adjusting the third point of the tractor, thus ensuring the same depth of processing for the first and second row of discs.

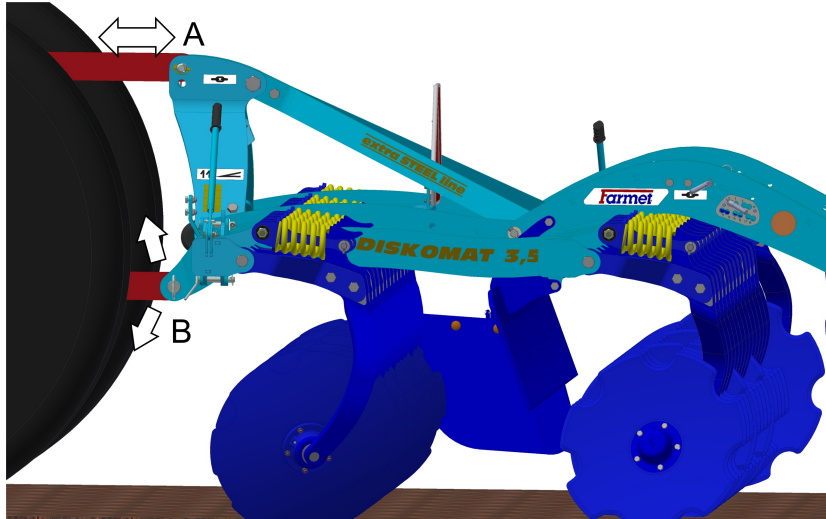

- A – Setting the drawbar length
- B – Setting the tractor arms height

The machine features high stability during operation. However turning of machine to one side may occur with fault adjusted longitudinal plane (particularly in heavy soils). This is removed by modification of tractor arm height as follows:

- When turning the machine to the left, the front discs are set lower  $\Rightarrow$  lift the machine in the tractor arms and extend the third-point drawbar
- When turning the machine to the right, the front discs are set higher  $\Rightarrow$  recess the front part of the machine in the tractor arms and shorten the third-point drawbar

## 10.3 Setting the side deflector

- Set the height of the side deflector so that it can catch soil flying from the front edge disc and thus create a levelled surface between the individual operating drives.

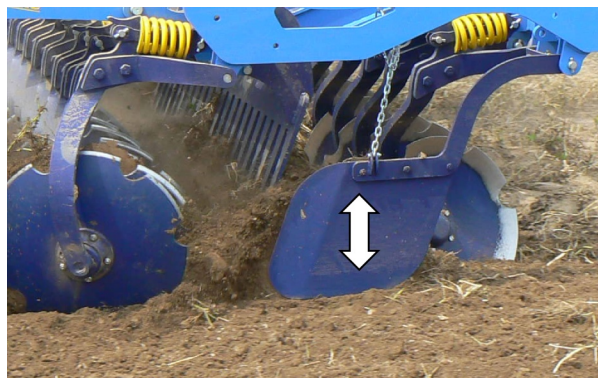



## 10.4 Fixing the position of the roller

- Use the top pin on the rear frame gate to secure undesirable falling of rear frames with the roller to the main frame of the machine when lifting at the headland. Insert the top pin in the closest hole to the position stop after the machine has been recessed.

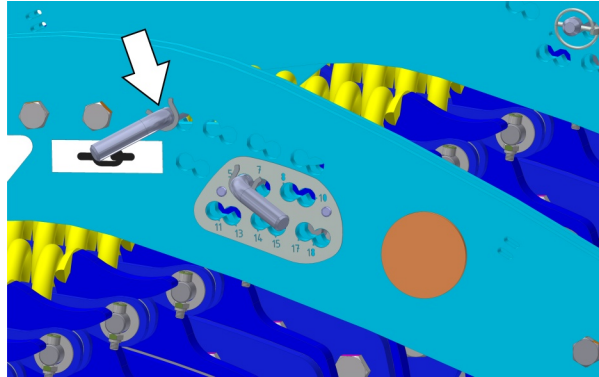



## 11 MACHINE MAINTENANCE AND REPAIRS



Observe the safety instructions for treatment and maintenance.

- If it is necessary to weld during the repair and have the machine connected to the tractor, it must have disconnected supply cables from the alternator and the accumulator.
- Check the tightening of all screw and other assembly connections at the machine before every use of the machine, furthermore continuously as needed.
- Continuously check the wear of the working bodies of the machine, possibly replace these worn working bodies with new ones.
- Adjustment, cleaning, and lubrication of the machine may only be performed with the machine at rest (i.e. the machine is standing and not working).
- When working on a lifted machine, use suitable support equipment supported at marked points or at points suitable for that.
- During adjustment, cleaning, maintenance, and repair of the machine, you must secure those parts of the machine that could endanger the operator by falling or another movement.
- For catching the machine during handling using lifting equipment, use only the places marked with self-adhesive labels with the chain sign.
- Upon a failure or damage of the machine, immediately turn off the tractor's engine and secure against restarting, secure the machine against movement  only then you can remove the failure.
- During repairs of the machine, use exclusively the genuine spare parts, suitable tools and protective equipment.
- Keep the machine clean.



Do not clean bearings with a high-pressure cleaner or direct water stream. The seals and bearings are not watertight at high pressure.

### 11.1 Tightening and securing the disc bearings (does not apply to maintenance-free bearings)

- First of all, tighten the screw nut and move the block around so that the bearings fit in the block. After that release the screw nut and tighten it again by 32Nm pulling torque. Furthermore, the screw nut has to be secured by snapping it into the shaft groove.

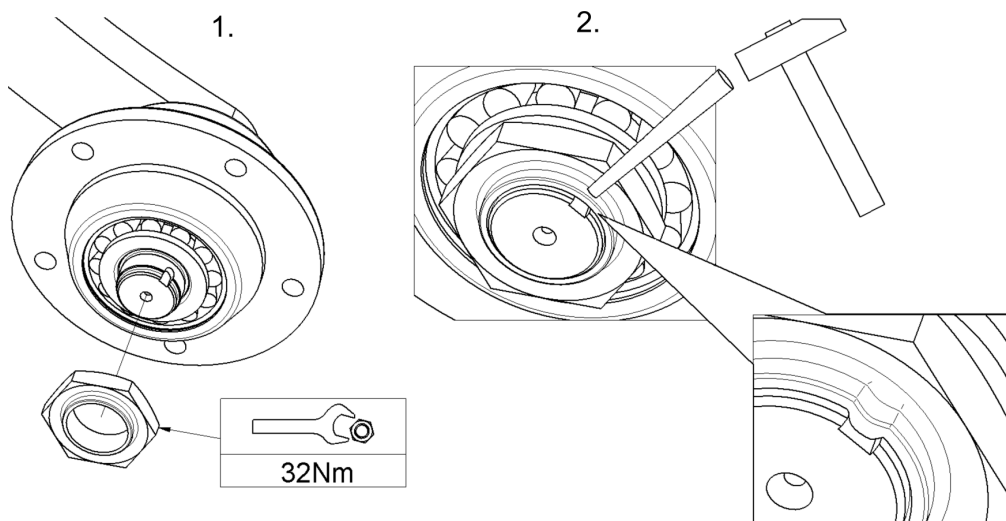

## 12 MACHINE STORAGE

### Long-term machine shutdown:

- Store the machine under a roof if possible.
- Store the machine on a flat and solid surface with sufficient load capacity.
- Clean the machine before storing and conserve so that it is not damaged in any way during storage. Pay special attention to all marked lubrication points and properly lubricate them according to the lubrication plan.
- Secure the machine against access of unauthorised persons.

### 13 MACHINE LUBRICATION SCHEDULE

- During machine maintenance and its lubrication, it is necessary to observe the safety regulations.

LUBRICATION POINT	INTERVAL	LUBRICANT
Disc bearings*	Always after the end of the season and before storing the machine.	Plastic grease KP2P-20 Likx dle DIN 51 502

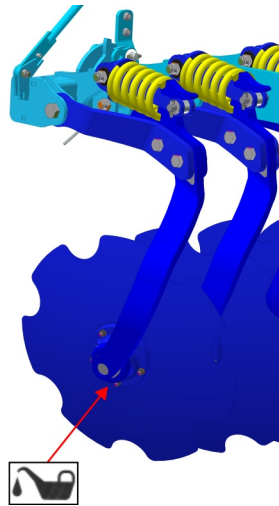

**Lubricant handling:**

- Protect yourselves against direct contact with oils by using gloves or protective creams.
- Thoroughly wash oil spots on the skin using warm water and soap.
- Do not clean the skin with petrol, engine diesel fuel or other solvents.
- Oil is poisonous. If you swallowed the oil, immediately seek a physician.
- Protect the lubricants against children.

## 14 ENVIROMENTAL PROTECTION

- Handle oils and greases according to valid waste laws and regulations.

## 15 MACHINE DISPOSAL AFTER SERVICE LIFE EXPIRY

- The operator must secure during machine disposal that steel parts and parts, in which hydraulic oil or lubricating grease moves are differentiated.
- Steel parts must be cut by the operator while observing safety regulations and handed over to the secondary raw material collection point. He must proceed with other parts according to valid laws about waste.

## 16 SERVICING AND WARRANTY CONDITIONS

### 16.1 Servicing

Servicing is secured by the dealer after consulting with the manufacturer, possibly directly by the manufacturer. Spare parts then using the sales network by individual sellers in the entire country. Use only the spare parts according to the spare parts catalogue officially issued by the manufacturer.

### 16.2 Warranty

1. The manufacturer provides a warranty of 24 months for these machine parts: main frame, axle, and machine tow bar. For other parts of the machine, the manufacturer provides a warranty of 12 months. The warranty is provided from the date of sale of the new machine to the end user (consumer).
2. The warranty applies to hidden defects that will show in the warranty period with proper use of the machine and while fulfilling the conditions stated in the operating manual.
3. The warranty does not apply to wearable spare parts, i. e. regular mechanical wear and tear of replaceable parts of the working sections (shares, edges, etc.).
4. The warranty does not apply to indirect consequences of possible damage, such as service life decrease etc.
5. The warranty is bound to the machine and is not void upon an owner change.
6. The warranty is limited to the disassembly and assembly, possibly replacement or repair of the defective part. The decision, whether to replace or repair the defective part, is up to the contractual workshop of Farmet.
7. During the warranty period, only the authorised servicing technician of the manufacturer may perform repairs or other interventions into the machine. In the opposite case, the warranty will not be acknowledged. This provision does not apply to the replacement of wearable spare parts (see point 3).
8. The warranty is conditioned by using the genuine spare parts of the manufacturer.

2013/001/01

(CZ) **ES PROHLÁŠENÍ O SHODĚ**  
 (GB) **CE CERTIFICATE OF CONFORMITY**  
 (D) **EG-KONFORMITÄTSERKLÄRUNG**  
 (F) **DÉCLARATION CE DE CONFORMITÉ**  
 (RU) **СЕРТИФИКАТ СООТВЕТСТВИЯ ЕС**  
 (PL) **DEKLARACJA ZGODNOŚCI WE**

1. (CZ) My (GB) We (D) Wir (F) Nous (RU) Мы (PL) My: **Farmet a.s.**  
 Jiřínková 276  
 552 03 Česká Skalice  
 Czech Republic  
 DIČ: CZ46504931  
 Tel/Fax: 00420 491 450136

(CZ) Vydáváme na vlastní zodpovědnost toto prohlášení. (GB) Hereby issue, on our responsibility, this Certificate. (D) Geben in alleiniger Verantwortung folgende Erklärung ab. (F) Publiions sous notre propre responsabilité la déclaration suivante. (RU) Под свою ответственность выдаем настоящий сертификат. (PL) Wydajemy na własną odpowiedzialność niniejszą Deklarację Zgodności.

2. (CZ) Strojní zařízení: - název : **Diskový podmítač**  
 (GB) Machine: - name : **Disk plough-harrow**  
 (D) Fabrikat: - Bezeichnung : **Kurzscheibenegge**  
 (F) Machinerie: - dénomination : **Déchaumeur à disques**  
 (RU) Сельскохозяйственная машина: - наименование : **Дисковый лушильник**  
 (PL) Urządzenie maszynowe: - nazwa : **Talerzowy plug podorywkowy**
- typ, type : **DISKOMAT**  
 - model, modèle : **DISKOMAT 3; 3,5**  
 - (CZ) výrobní číslo :   
 - (GB) serial number  
 - (D) Fabriknummer  
 - (F) n° de production  
 - (RU) заводской номер  
 - (PL) numer produkcyjny:

3. (CZ) Příslušná nařízení vlády: č.176/2008 Sb. (směrnice 2006/42/ES). (GB) Applicable Governmental Decrees and Orders: No.176/2008 Sb. (Directive 2006/42/ES). (D) Einschlägige Regierungsverordnungen (NV): Nr.176/2008 Slg. (Richtlinie 2006/42/ES). (F) Décrets respectifs du gouvernement: n°.176/2008 du Code (directive 2006/42/CE). (RU) Соответствующие постановления правительства: № 176/2008 Сб. (инструкция 2006/42/ES). (PL) Odpowiednie rozporządzenia rządowe: nr 176/2008 Dz.U. (Dyrektywa 2006/42/WE).

4. (CZ) Normy s nimiž byla posouzena shoda: (GB) Standards used for consideration of conformity: (D) Das Produkt wurde gefertigt in Übereinstimmung mit folgenden Normen: (F) Normes avec lesquelles la conformité a été évaluée: (RU) Нормы, на основании которых производилась сертификация: (PL) Normy, według których została przeprowadzona ocena: ČSN EN ISO 12100, ČSN EN ISO 4254-1.

(CZ) Schválil (GB) Approve by dne: 01.02.2013  
 (D) Bewilligen (F) Approuvé  
 (RU) Утвердил (PL) Uchwalif

**p. Gavlas Dušan**  
 technický ředitel  
 Technical director

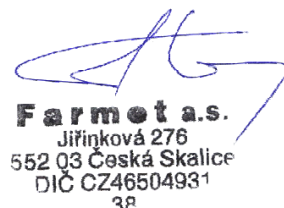

**Farmet a.s.**  
 Jiřínková 276  
 552 03 Česká Skalice  
 DIČ CZ46504931  
 3P

V České Skalici dne: 01.02.2013

**Ing. Karel Žďárský**  
 generální ředitel společnosti  
 General Manager

